

Your Global Automation Partner

TURCK

BL ident[®] RFID System Planning and Engineering

User Manual

Contents

1	About this Manual	7
1.1	Target Groups	7
1.2	Explanation of Symbols	7
1.3	Other Documents	8
1.4	Naming Convention	8
1.5	Feedback about These Instructions	8
2	About the Product	9
2.1	Identification of Components	9
2.1.1	Interface – Type Codes	9
2.1.2	Read/Write Heads – Type Code	12
2.1.3	Tags – Type Code	13
2.1.4	Connection Technology – Type Code	14
2.1.5	Handhelds – Type Codes	15
2.2	Legal Requirements	16
2.3	Manufacturer and Service	16
3	For Your Safety	17
3.1	Intended Use	17
3.2	Obvious Misuse	17
3.3	General Safety Instructions	18
3.4	Notes on Ex Protection	19
4	System Description	20
4.1	System Features	20
4.2	System Setup	21
4.3	Operating Principle	23
4.4	Typical Application Areas	23
4.5	TBEN and BL Series – Interfaces Compared	24
4.6	BL ident® – System Levels and Programming Environments	26
4.7	HF RFID and UHF RFID Compared	28
5	System Components	29
5.1	Modular Interfaces – BL Series	29
5.1.1	Type Code	29
5.1.2	Features	31
5.1.3	Design of BL ident® Interfaces	32
5.1.4	Operating Principle	33
5.1.5	Interface Sets – Gateways (BL20 and BL67)	34
5.1.6	Interface Sets – RFID Modules (BL20 and BL67)	35
5.1.7	Compact Interface – BL compact	37
5.1.8	Functions and Operating Modes	38
5.1.9	Operating and Indication Elements	39
5.1.10	Available Device Types	40
5.1.11	Possible Combination of Interfaces/Gateways and RFID Modules	54
5.1.12	Accessories	57

5.2	Compact Multiprotocol Interfaces – TBEN Series	58
5.2.1	Type Code	58
5.2.2	Features	59
5.2.3	Design of TBEN Interfaces	60
5.2.4	Operating Principle	61
5.2.5	Functions and Operating Modes	61
5.2.6	Operating and Indication Elements	64
5.2.7	Available Device Types	65
5.3	HF Read/Write Heads	66
5.3.1	Type Codes	66
5.3.2	Features of the HF Read/Write Heads	67
5.3.3	Setup of the HF Read/Write Heads	67
5.3.4	Operating Principle	68
5.3.5	Functions and Operating Modes	69
5.3.6	Operating and Indication Elements	70
5.3.7	Available Device Types	71
5.3.8	Combination of HF Read/Write Heads and HF Tags	77
5.3.9	Accessories – HF Read/Write Heads	87
5.4	HF Tags	91
5.4.1	Type Code	91
5.4.2	Features of the HF Tags	92
5.4.3	Setup of the HF Tags	93
5.4.4	Operating Principle	93
5.4.5	User Data Areas of Tags	94
5.4.6	Available Device Types	95
5.4.7	Accessories	108
5.5	UHF Read/Write Heads	110
5.5.1	Type Code	110
5.5.2	Features of the UHF Read/Write Heads	111
5.5.3	Setup of the UHF Read/Write Heads	111
5.5.4	Operating Principle	112
5.5.5	Firmware Status	112
5.5.6	Operating and Indication Elements	113
5.5.7	Available Device Types	114
5.5.8	Combination of UHF Read/Write Heads and Tags	116
5.5.9	Accessories	118
5.6	UHF Tags	119
5.6.1	Type Code	119
5.6.2	Features of the UHF Tags	120
5.6.3	Setup of the UHF Tags	121
5.6.4	Operating Principle	121
5.6.5	User Data Areas of Tags	122
5.6.6	Available Device Types	129
5.7	Handhelds	136
5.7.1	Type Code	136
5.7.2	Features of the TA Handheld	137
5.7.3	Features of SMART Handhelds	137
5.7.4	Features of the NID Handheld	137
5.7.5	Features of the PD20 Handheld	137
5.7.6	Setup of the Handhelds	138
5.7.7	TA Handhelds Operating Principle	138
5.7.8	Operating/Indication Elements of TA Handhelds	139
5.7.9	Functions and Operating Modes of TA Handhelds	139
5.7.10	Customized Software Solutions	140
5.7.11	Available Device Types	141
5.7.12	Accessories	144

5.8	Connection Technology	145
5.8.1	Type Code	145
5.8.2	Features	145
5.8.3	Connection Technology Design	145
5.8.4	Available Device Types	146
5.9	BL ident® HF Simulator	151
6	Planning and Preparing the Use of a BL ident® System	152
6.1	Clarify Requirements of HF Applications	152
6.1.1	Transmission Frequency	152
6.1.2	Lifespan of the Tags	152
6.1.3	Degree of Protection	152
6.1.4	Compatibility	153
6.1.5	Transmission Zone and Read/Write Distance	154
6.1.6	Minimum Distance of Tag and Read/Write Head	154
6.1.7	Permissible Motion Direction and Alignment of the Tags	154
6.1.8	Reading and Writing in Static Mode	154
6.1.9	Reading and Writing in Dynamic Mode (on the Fly)	154
6.1.10	Read Time/Write Time	155
6.1.11	Passing Speed	158
6.1.12	Read/Write Distance	159
6.1.13	Dwell Time of the Tag	159
6.1.14	Calculating the Max. Quantity of User Data in Single Mode	160
6.1.15	Minimum Distance between Two Tags in Single Mode	160
6.1.16	Minimum Distance between Two Tags in Multiple Access	160
6.2	Clarifying the Requirements of UHF Applications	161
6.2.1	Transmission Frequency	161
6.2.2	Lifespan of the Tags	161
6.2.3	Degree of Protection	162
6.2.4	Compatibility	162
6.2.5	Transmission Zone and Read/Write Distance	163
6.2.6	Minimum Distance of Tag and Read/Write Head	164
6.2.7	Permissible Motion Direction and Alignment of the Tags	164
6.2.8	Reading and Writing in Static Mode with UHF	164
6.2.9	Reading and Writing in Dynamic Mode (on the Fly) with UHF	164
6.2.10	Read Time/Write Time	164
6.2.11	Passing Speed	165
6.2.12	Read/Write Distance	165
6.2.13	Dwell Time of the Tag	166
6.2.14	Minimum Distance between two Tags in Single Mode	166
6.2.15	Requirements for Multiple Access	167
6.2.16	Interaction with Several Read/Write Heads	167
6.3	Effect on UHF RFID Systems	173
6.3.1	Electromagnetic Waves – Reflections and Interference	173
6.3.2	Reducing the Effect of Reflections and Interference	173
6.3.3	Effect of Liquids and Non-Metallic Substances	173
6.3.4	Effect of Third Party Components	174
6.4	Electromagnetic Compatibility (EMC)	175
6.4.1	Electromagnetic Compatibility – Definition	175
6.4.2	Cause of Electromagnetic Interference	175
6.4.3	Basic Measures for Ensuring EMC	176
6.4.4	Possible Disturbance Factors and Countermeasures in RFID Applications	179

7	Maintenance	179
8	Repair	179
8.1	Returning Devices	179
9	Disposal	179
10	EC Conformity/Approvals	180
10.1	Interfaces	180
10.2	HF Read/Write Heads	181
10.3	UHF Read/Write Heads	182
11	Glossary	183

1 About this Manual

This manual describes the setup, the functions and use of the system and helps you to plan and design the system for its intended purpose.

Read this manual carefully before using the system. This will prevent the risk of personal injury or damage to property or equipment. Keep this manual safe during the service life of the system. If the system is passed on, hand over this manual as well.

1.1 Target Groups

This manual is designed for use by suitably qualified and trained personnel and must be read by anyone entrusted with commissioning, operation, maintenance, disassembly or disposal.

1.2 Explanation of Symbols

Warnings related to actions are placed in front of potentially dangerous operating steps and are indicated with graphical symbols. Each warning is introduced with a warning symbol and a key word expressing the severity of the danger. The instructions must be observed in all cases:



DANGER

DANGER indicates an immediate hazardous situation that, if not avoided, will result in death or serious injury.



WARNING

WARNING indicates a possible hazardous situation with the risk of death or serious injury if it is not prevented.



NOTICE

NOTICE indicates a situation that may cause possible damage to property if it is not prevented.



NOTE

NOTE indicates tips, recommendations and important information. The notes simplify work, contain information on particular operating steps and help to avoid additional work resulting from incorrect procedures.



MANDATORY ACTION

This symbol denotes actions that the user must carry out.



RESULT OF ACTION

This symbol denotes the relevant results of actions and procedures.

1.3 Other Documents

Besides this document the following material can be found on the Internet at www.turck.com:

- D101578 - Commissioning in PROFIBUS-DP
- D101639 – Commissioning in CODESYS for programmable gateways
- D101641 – Commissioning in DeviceNet™
- D101643 – Commissioning in EtherNet/IP™
- D101647 – Commissioning in PROFINET
- D101762 - Commissioning in CANopen
- D500032 – BL ident® Software TA-HF
- D500050 – BL ident® Software TA-HF
- D500034 – PD-IDENT...TA BL ident® handheld
- D500037 – Commissioning in Modbus TCP
- D500063 – Operating instructions TBEN-S2-2RFID-4DXP
- D500070 – Operating instructions TBEN-L...-4RFID-8DXP-CDS
- Product-specific data sheets

The free Turck BL ident® Simulator for optimizing and simulating an application is available at www.turck.com.

1.4 Naming Convention

Common synonyms for “tags” are “data carriers”, “transponders” and “mobile data memory”.
Read/write heads are also called “transceivers”.

1.5 Feedback about These Instructions

We make every effort to ensure that these instructions are as informative and as clear as possible. If you have any suggestions for improving the design or if some information is missing in the document, please send your suggestions to techdoc@turck.com.

2 About the Product

BL ident® is a modular RFID system for use in industrial environments. The system allows HF technology (13.56 MHz) and UHF technology (865...928 MHz) to be run in parallel. The system consists of several components and levels that can be flexibly combined:

- Interfaces for connecting the fieldbus and RFID level
- Read/write heads for the HF and UHF range
- Tags for the HF and UHF range
- Connection cables
- Handhelds for the mobile writing and reading of data (optional)

2.1 Identification of Components

2.1.1 Interface – Type Codes

Modular Interface Sets in IP20 and IP67 – BL Series

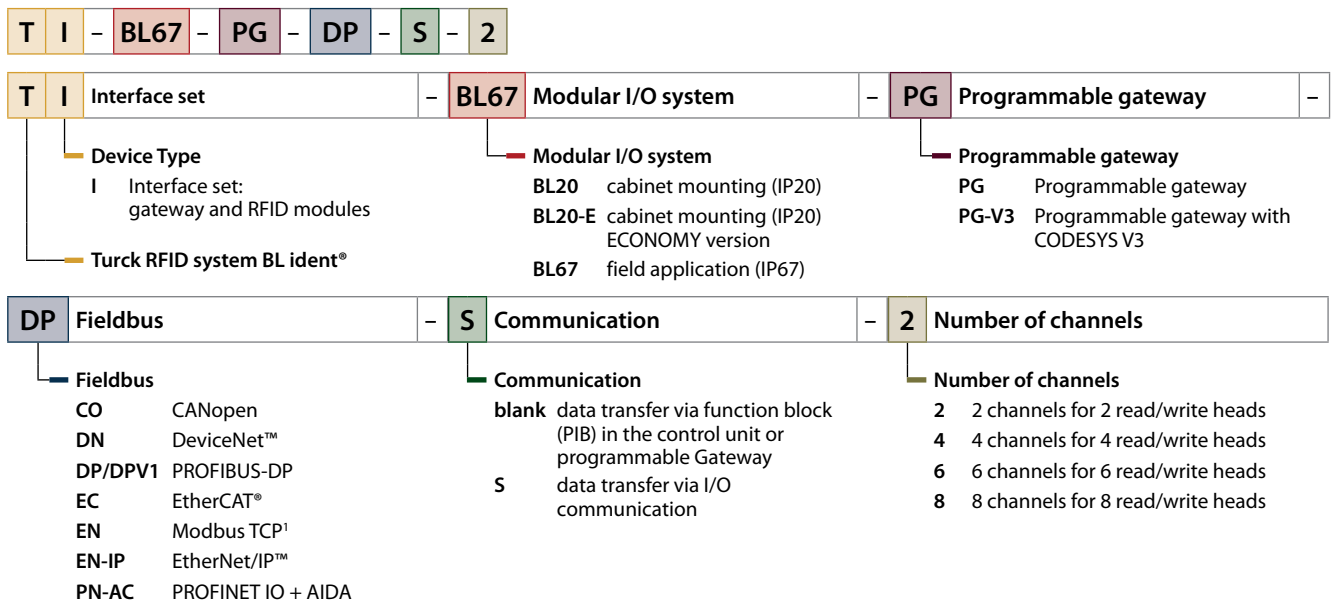

¹ TI-BL67-EN-S-x and TI-BL20-EN-S-x with multiprotocol: Modbus TCP, EtherNet/IP™ and PROFINET

Compact Interfaces – BL compact for BL ident®

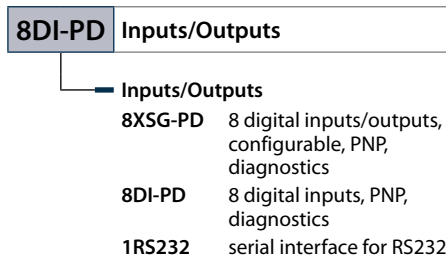
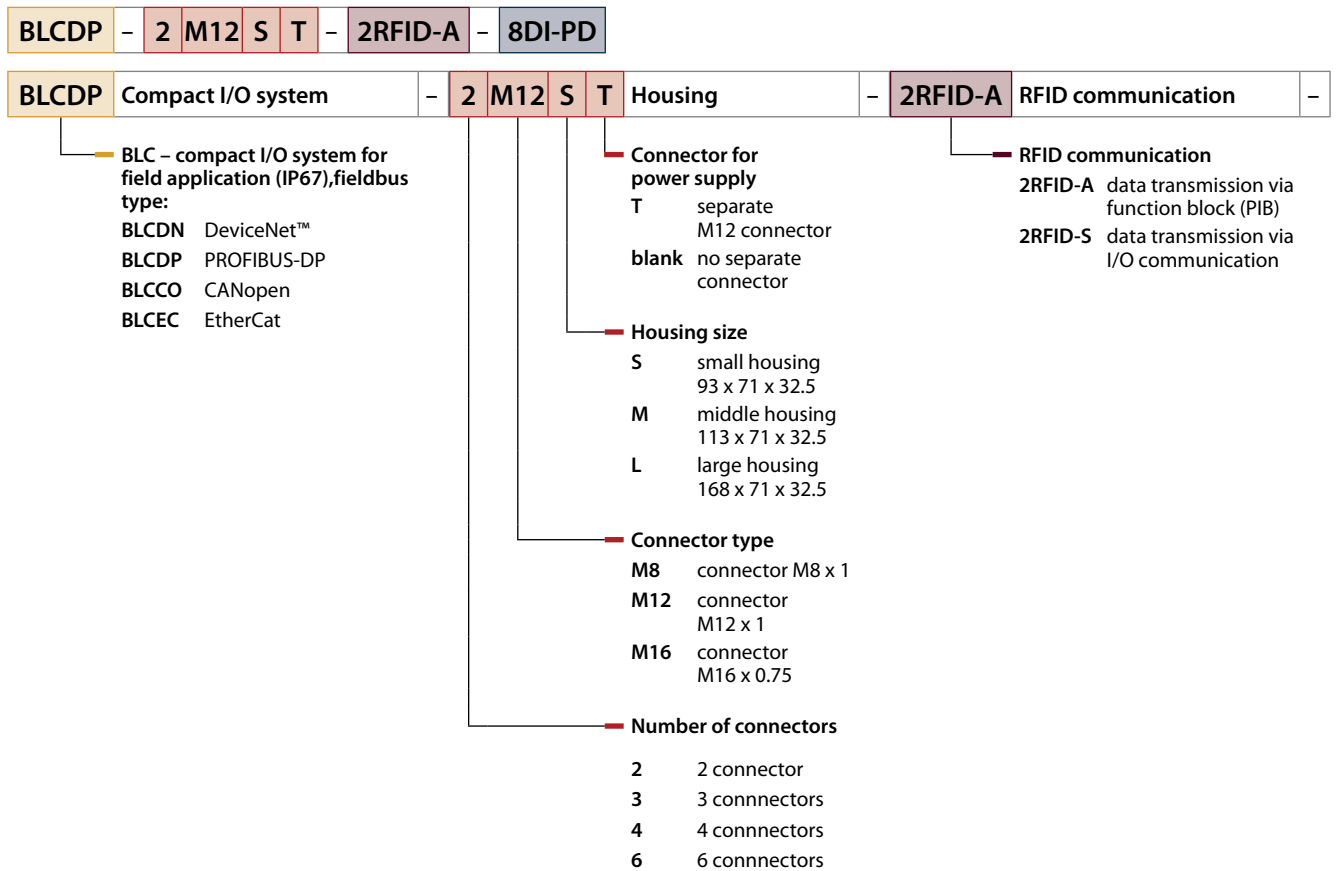

Compact Multiprotocol Interfaces – TBEN Series

TB EN - L5 - 4RFID - 8DXP - CDS

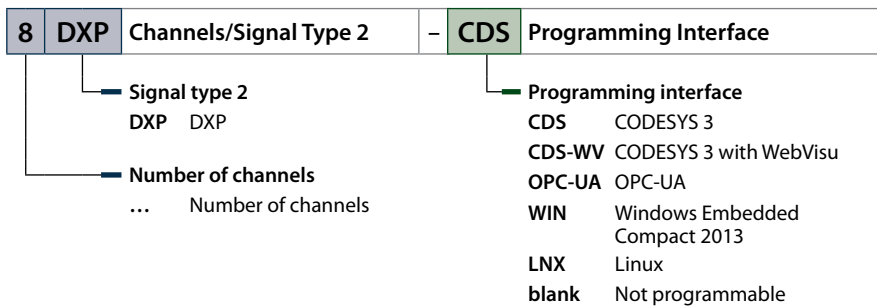
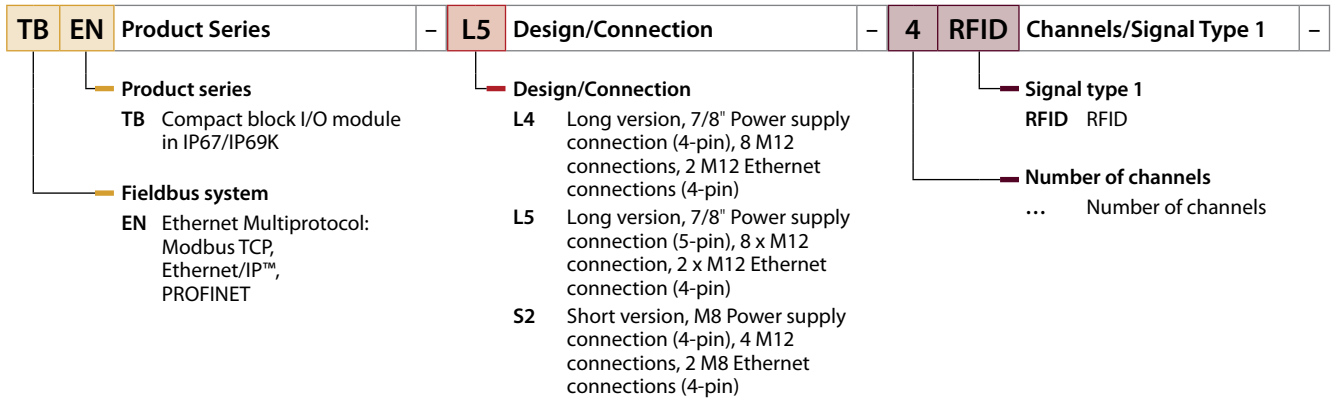

2.1.2 Read/Write Heads – Type Code

T N LR ... - Q80 - H1147 - * / C53

T	N	LR	...	Read/write head	-	Q80	Housing	-	H1147	Connector type	-
				Working frequency blank 13.56 MHz 865 865...868 MHz 866 866...868 MHz 902 902...928 MHz 840/ 840.5...844.5 MHz & 920 920.5...924.5 MHz 902/ 902...907,5 MHz & 915 915...928 MHz 917 917...920.8 MHz Special range LR long range SLR super long range Read/write heads, mounting condition B flush mountable N non-flush mountable Turck RFID-System BL ident®			Housing CK40 rectangular 40 x 40 x 65 mm, variable orientation of active face EM18WD thread M18, stainless steel, wash down (IP69K) EM30WD thread M30, stainless steel, wash down (IP69K) M18 thread M18 M30 thread M30 Q08 rectangular, 32 x 20 x 8 mm Q14 rectangular 55.5 x 30 x 14 mm Q42TWD rectangular, 68 x 42,5 x 42,5 mm, active face on top, wash down (IP69K) Q80 rectangular, 114 x 80 x 40 mm Q80L400 rectangular, 400 x 80 x 25 mm Q80WD rectangular, 83 x 102 x 40 mm, wash down (IP69K) Q120L130 rectangular, 120 x 130 x 60 mm Q175L200 rectangular, 175 x 200 x 60 mm Q175 rectangular, 175 x 200 x 60 mm Q350 rectangular, 370 x 350 x 20 mm S32XL ring shaped, 180 x 120 x 32 mm		Connector 0.15-RS4.47T pigtail (150 mm) with male connector M12 H1147 connector M12 x 1 H1147L connector M12 x 1, lateral		

*** Approvals / C53 Special Version**

Approvals (optional)
 Ex approval for Ex-Area

Special version
 C53 Bus-capable, setup of line topology
 with TBEN possible
 (HF Bus mode)

2.1.3 Tags – Type Code

T **W** ... - **Q51** - **M** - **HT** - **B128** - **Ex**

T	W	...	Data carrier	-	Q51	Housing	-	M	Features	-
			<ul style="list-style-type: none"> Working frequency <ul style="list-style-type: none"> blank 13.56 MHz 865-868 865...868 MHz 865-928 865...928 MHz 860-960 860...960 MHz 902-928 902...928 MHz Data carrier, memory access <ul style="list-style-type: none"> W read/write R read only Turck RFID-System BL ident® 		<ul style="list-style-type: none"> Housing <ul style="list-style-type: none"> BD10X1.5-19 screw housing, plastic, M10 x 1.5, wrench size 19 mm BS10X1.5-19 screw housing, metal/plastic, M10 x 1.5, wrench size 19 mm BV10X1.5-19 screw housing, stainless steel/plastic, M10 x 1.5, wrench size 19 mm I... inlay & dimensions L... label & dimensions Q...L... rectangular & diameter Q51 rectangular & lateral length: 51 mm R... round & diameter 		<ul style="list-style-type: none"> Features <ul style="list-style-type: none"> C cheque card format F foil data carrier M for direct mounting on metal MF for direct mounting on metal, foil shielded P paper data carrier 			

HT	High temperature (optional)	-	B128	Memory capacity total	-	Ex	Approvals
	<ul style="list-style-type: none"> High temperature <ul style="list-style-type: none"> HT High temperature 		<ul style="list-style-type: none"> Memory capacity total (size) <ul style="list-style-type: none"> B... ... Byte K... ... kByte 		<ul style="list-style-type: none"> Approvals <ul style="list-style-type: none"> Ex Approval for Ex-Area 		

2.1.4 Connection Technology – Type Code

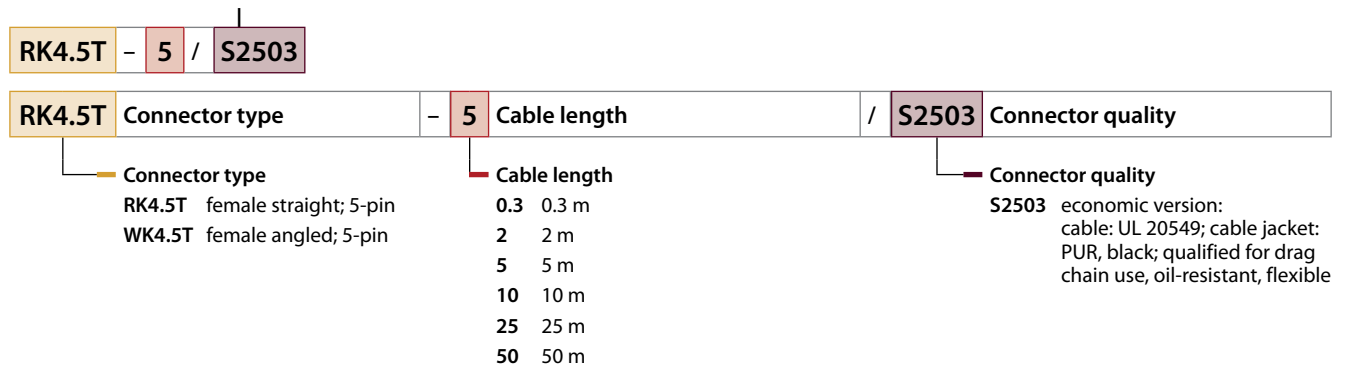

2.1.5 Handhelds – Type Codes

PD ident Handhelds

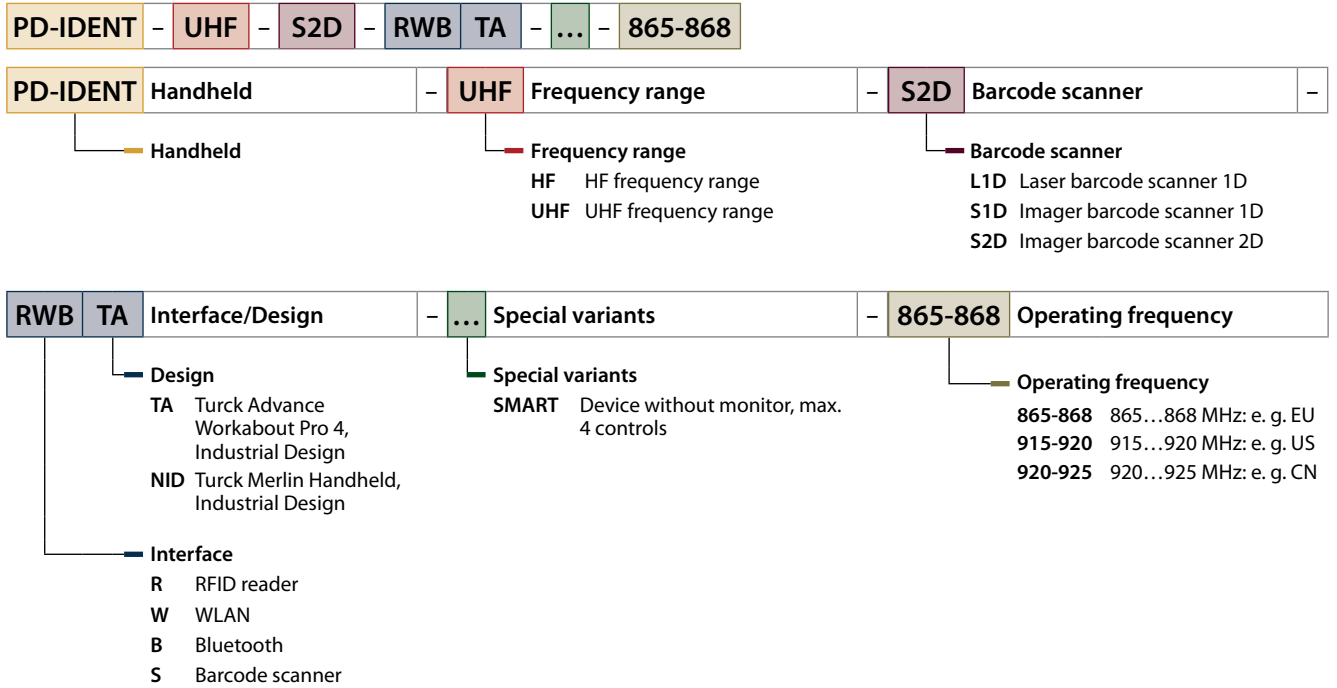

PD20 Handhelds

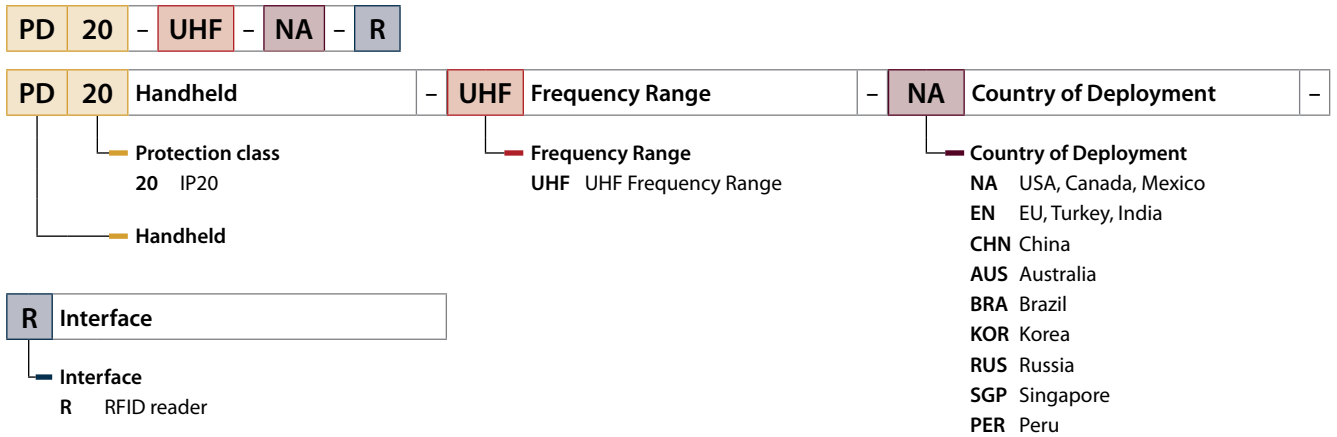

2.2 Legal Requirements

The system is subject to the following EU Directives:

- 2014/30/EC (EMC Directive)
- 2014/35/EC (Low-Voltage Directive)
- 2014/34/EC (ATEX Directive)
- 2014/53/EC (RED Directive)
- 2011/65/EC (RoHS Directive)

The system consists of different components which do not all comply with the same directives and which are also developed and manufactured according to different standards. Refer to the relevant EC declarations of conformity to find the relevant directives and standards for individual components. The EC declarations of conformity are available for download from the Turck product database at www.turck.com.

2.3 Manufacturer and Service

Turck supports you in your projects – from the initial analysis right through to the commissioning of your application. The Turck product database offers you several software tools for programming, configuring or commissioning, as well as data sheets and CAD files in many export formats. You can access the product database directly via the following address:

www.turck.de/products

For further inquiries in Germany contact the Sales and Service Team on:

Sales: +49 208 4952-380

Technical: +49 208 4952-390

Internet: www.turck.com/support

For overseas inquiries contact your national Turck representative.

Hans Turck GmbH & Co. KG
Witzlebenstraße 7
45472 Mülheim an der Ruhr
Germany

3 For Your Safety

The product is designed according to the latest state-of-the-art technology. Residual hazards, however, still exist. Safety instructions and warnings must be observed in order to prevent injury to persons and possible damage. Turck accepts no liability for damage caused by failure to observe these safety instructions and warnings.

3.1 Intended Use

The system is designed exclusively for use in industrial areas.

The Turck BL ident® system is used for the contactless exchange of data between a tag and a read/write head in order to identify objects in industrial environments.

Any other use is not in accordance with the intended use and may cause injury to persons and possible damage. Turck is not liable for damage arising from improper use of the system.

3.2 Obvious Misuse

The system is not suitable for the protection of persons and property and must not be used in safety-related applications.

3.3 General Safety Instructions

Any incorrect use of the system may cause accidents.

- The system must only be fitted, installed, operated and maintained by trained and qualified personnel. When using the device in Ex circuits, the user must also have an additional knowledge of explosion protection (EN 60079-14 etc.).
- Only use the system in compliance with the applicable national and international regulations, standards and laws.

Faulty repairs may cause device failure and accidents.

- Do not intervene in system components or convert them.
- Send the devices to Turck for repair.

Any extended stay within the area of radiation of the HF read/write heads may be harmful to health.

- Observe minimum distances from the actively radiating surface of the HF read/write head:

Device	Safety distance
TB-M18-H1147	6.8 cm
TN...-M18 L200-H1147	6.8 cm
TB-M30-H1147	8.3 cm
TN-M30-H1147	8.3 cm
TN-Q80-H1147	19.9 cm
TNLR-Q80-H1147	19.9 cm
TB-Q08-0.15-RS4.47T	1.3 cm
TN-CK40-H1147	3.8 cm
TNLR-Q80L400-H1147	15.2 cm
TNLR-Q80L800-H1147	44.7 cm
TNSLR-Q350-H1147	42.4 cm
TN-Q14-0.15-RS4.47T	1.0 cm
TNSLR-Q80WD-H1147	9.2 cm
TNSLR-Q42TWD-H1147	8.7 cm

Any extended stay within the area of radiation of the UHF read/write heads may be harmful to health.

- Observe minimum distances from the actively radiating surface of the UHF read/write head:

Region	Max. permissible total radiant output power	Safety distance
Europe, Russia	2 W ERP (according to ETSI)	24 cm
USA/Canada, Brazil	4 W EIRP	> 30 cm

The radiation of the UHF read/write heads may have an adverse effect on the operation of electrically controlled medical equipment.

- Keep an additional distance from active radiation sources up to the maximum transmission distance.

3.4 Notes on Ex Protection

If protection measures are not implemented in Ex applications, there is a direct risk of explosion.

- Observe national and international regulations for explosion protection.
- Only use the device within the stated operating and ambient conditions (see technical data and Ex approval specifications).

4 System Description

BL ident® is a modular RFID system for use in industrial environments. The system allows HF technology (13.56 MHz) and UHF technology (865...928 MHz) to be run in parallel. The system consists of several components and levels that can be flexibly combined:

- Interfaces for connecting the fieldbus and RFID level
- Read/write heads for the HF and UHF range
- Tags for the HF and UHF range
- Connection cables
- Handhelds for the mobile writing and reading of data (optional)

4.1 System Features

- Can be used flexibly in different application areas
- Multiple combination options for tags, read/write heads and interface sets
- HF systems (13.56 MHz) and UHF systems (860...960 MHz) can be used in parallel
- Compatible with different fieldbus controller systems
- Tags and read/write heads with a high degree of protection (IP67/IP69K) available
- Interfaces in IP20, IP67 and IP69K

4.2 System Setup

The Turck RFID system has a modular design and consists of at least one interface for communication with the higher-level controller, one read/write head and one tag. Different variations are possible on each level, for example, in terms of the fieldbus system used, the design of the interfaces, or in terms of protection degree. This enables the BL ident® to be adapted easily to the particular requirements of an application and integrated into existing plant configurations. Standard software modules are available to ensure straightforward system integration and startup.

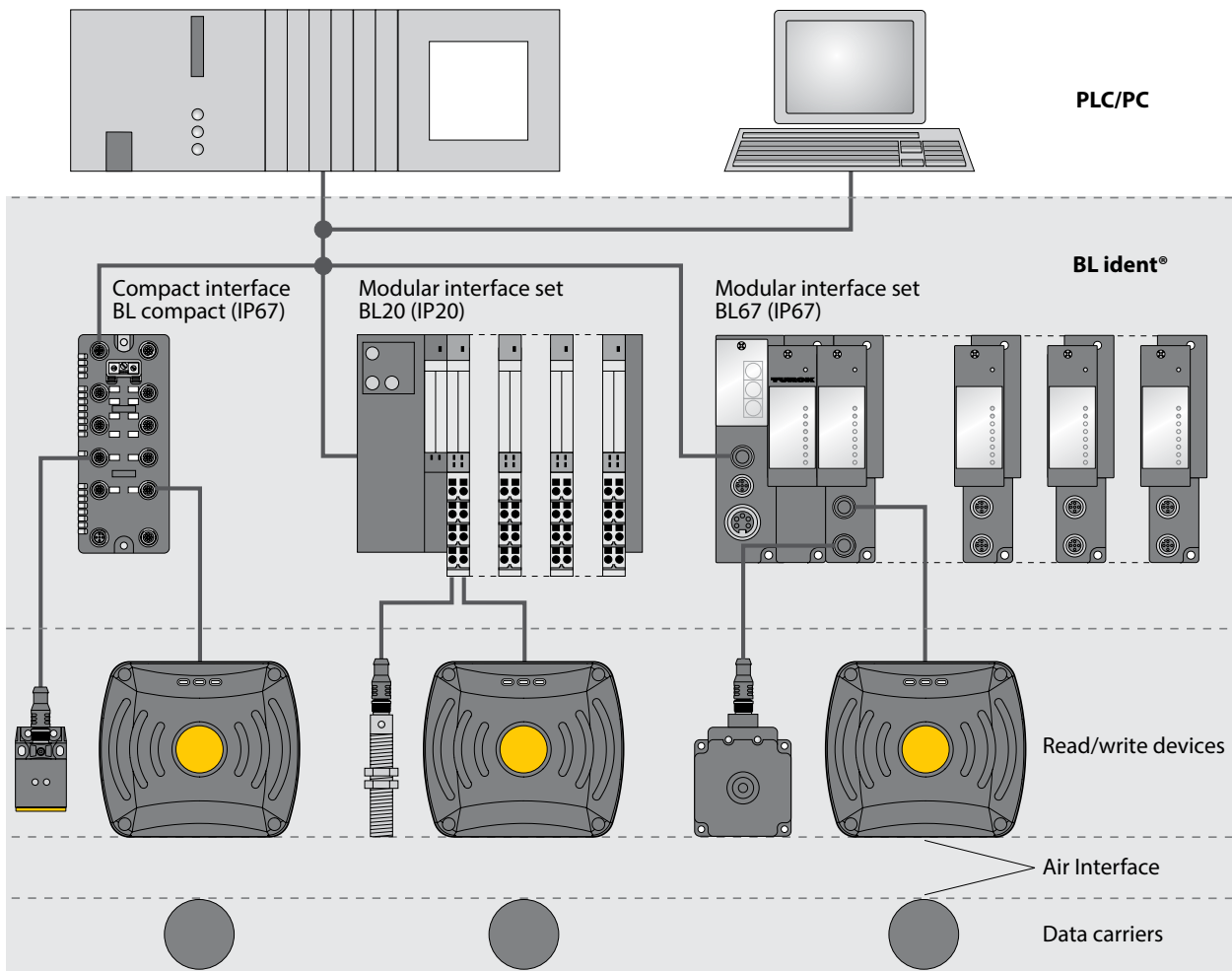

Fig. 1: BL ident® – System setup in different levels with modular interfaces (BL Series)

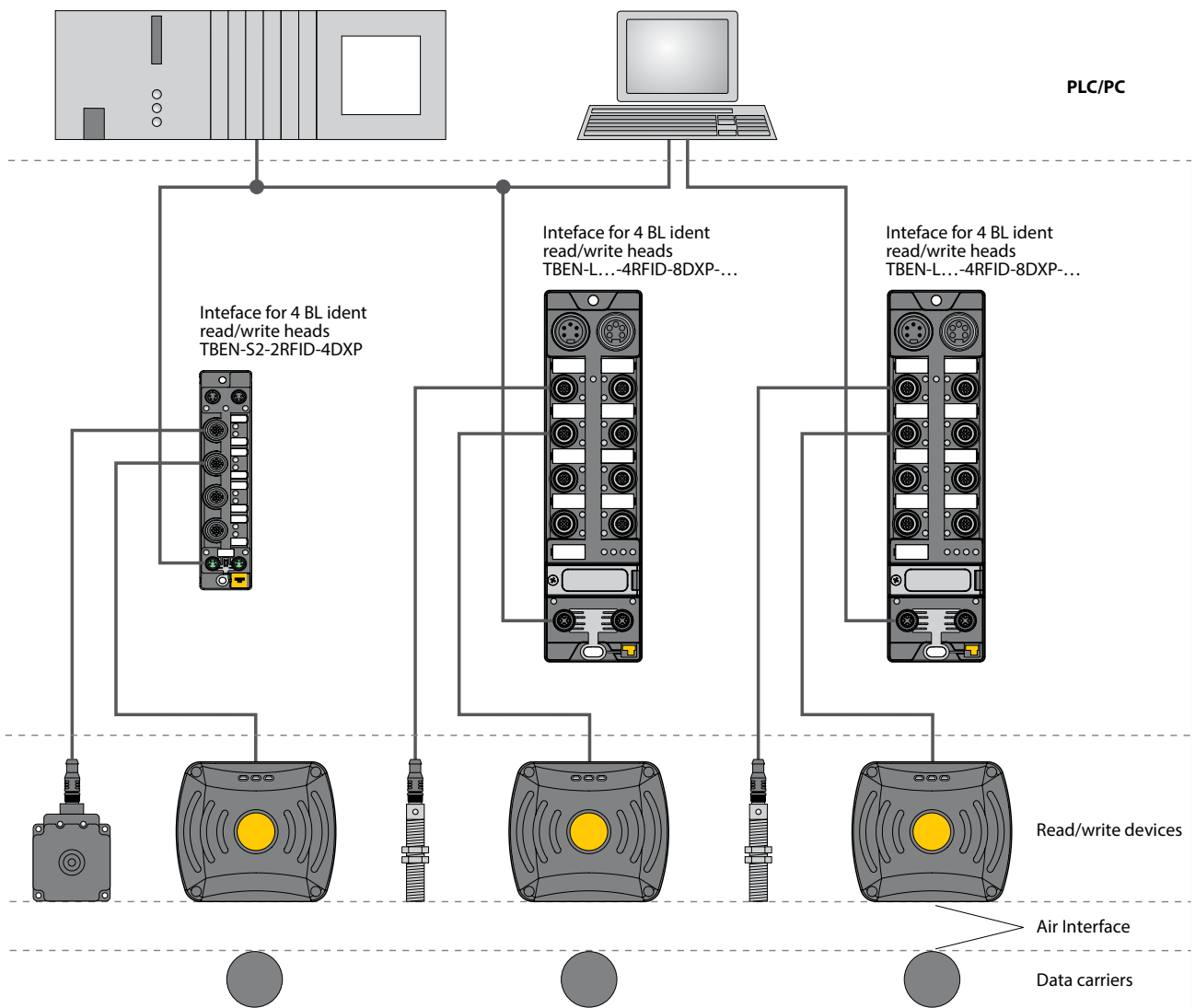

Fig. 2: System setup in different levels with compact interfaces (TBEN Series)

4.3 Operating Principle

RFID (radio frequency identification) is a contactless process for the automatic identification of static or moving objects by means of alternating electromagnetic fields. It uses, for example, the serial number of the object, which is stored on a mobile tag (transponder) and is read without contact by a read/write head (transceiver) over a distance of up to several meters. The RFID technology also enables multiple objects to be identified simultaneously; a direct line of sight connection between the tag and the read/write head is not necessary.

The interface translates the commands of a higher-level controller (e.g. reading the serial numbers of the tags in the field) for the read/write head and forwards the commands via RS 485 to the connected read/write heads. The read/write head codes the commands, sends them via the air interface to the tag and supplies the tag with power. The tag contains information which is transferred to the read/write head. The data is transferred back to the controller via the interface. The Turck RFID system allows HF technology (13.56 MHz) and UHF technology (865...928 MHz) to be run in parallel on one interface.

4.4 Typical Application Areas

The BL ident® system can be used in different industrial sectors:

- Automotive industry
- Transport
- Machine building
- Food and beverage
- Chemical industry
- Pharmaceutical industry
- Petrochemical industry

The following applications are possible:

- Following of production processes
- Assembly lines
- Materials handling
- Industrial production
- Warehouse management
- Logistics
- Distribution
- Control of goods flow
- Component picking
- Transport logistics
- Container management
- Coupling stations
- Tool and format change
- Product protection
- Automatic identification of vehicles, systems, tools, workpieces and products

4.5 TBEN and BL Series – Interfaces Compared

Different criteria must be taken into account for the interface selection. These are different for the compact TBEN block modules and the modular BL interface sets. The following table shows some important factors.

Selection criterion	TBEN Series	BL Series
Fieldbus interface	Ethernet multiprotocol – PROFINET – EtherNet/IP™ – Modbus TCP	PROFIBUS PROFINET Modbus TCP EtherNet/IP™ CANopen EtherCat® DeviceNet™
Function block	not required	BL...-2RFID-A: Proxy Ident Block (PIB) available for Siemens controllers and CODESYS-based BL systems BL67-2RFID-S: not required
Transferred data volume	up to 128 bytes of user data per write or read cycle per channel, larger data volumes transferrable with fragmentation	RFID-A module: 8 Kbytes with a command, data consistency with function block RFID-S module: 8 bytes per write or read cycle
Degree of protection	IP67/IP69K for direct field mounting	interface sets in IP20 for mounting in the control cabinet and in IP67 for direct field mounting
HF bus mode	HF: Up to 32 bus-capable read/write heads can be connected per channel	not available
Web server	web server for extensive parameter setting and execution of RFID commands	Ethernet gateways from hardware V03.00: web server for simple parameter setting of the RFID module
Automatic, repeated execution of commands such as Inventory, Read and Write (Continuous mode)	available	not available
Self triggering of UHF read/write heads	available in Presence Sensing mode	not available
Grouping of tags	tags with the same EPC can be grouped	not available
Automatic reading of UID	The UID is automatically written to the read data of the interface if a tag is located within the detection range of the read/write head	Inventory command required
Command timeout	defining the time in which a command is to be active	not available
Loop counter for fast command execution	available	not available
Transfer of EPC length	actual length is transferred	transfer of 8 bytes
Direct read/write head to execute special commands from the read/write head protocol	available	restricted availability
Transfer of additional information such as RSSI, phase and time stamp (UHF)	available	not available
Automatic control of written data	possible with "Write with validation" command	not available

Selection criterion	TBEN Series	BL Series
Tag counter	available for single tag and multitag applications	not available
Password function and setting of permanent tag locks (Lock)	available for HF and UHF applications	available for HF applications
Permanently deactivate UHF tags (Kill)	available	not available
Backup and restore function	available for UHF read/write heads	not available
Tunnel for parameter setting of read/write heads	TBEN as an interface for enhanced parameter setting of the UHF read/write heads via FDT/DTM	separate interface converter for enhanced parameter setting of UHF read/write heads required

The BL Series interfaces have different functions depending on the combination of gateway and electronic modules. Further information on different functions in section „**Selection Aid for the Interface Sets**“ on p. 56.

4.6 BL ident® – System Levels and Programming Environments

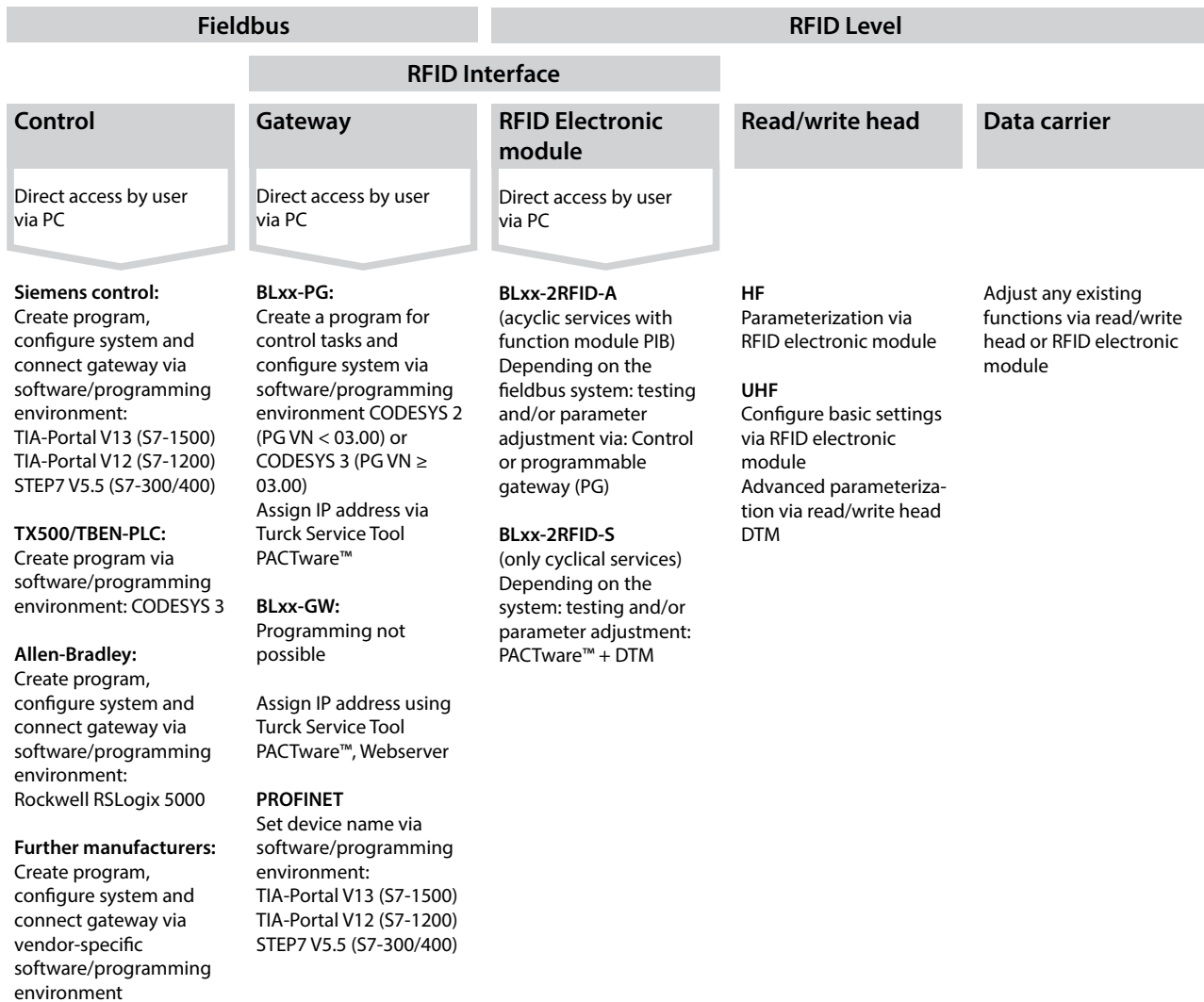

Fig. 3: Modular interfaces: Overview of BL ident® system levels and programming environments

Fieldbus		RFID Level	
Control	RFID Interface	Read/write head	Data carrier
Direct access by user via PC	Direct access by user via PC		
<p>Siemens control: Create program, configure system and connect gateway via software/programming environment: TIA-Portal V13 (S7-1500) TIA-Portal V12 (S7-1200) STEP7 V5.5 (S7-300/400)</p> <p>TX500/TBEN-PLC: Create program via software/programming environment: CODESYS 3</p> <p>Allen-Bradley: Create program, configure system and connect gateway via software/programming environment: Rockwell RSLogix 5000</p>	<p>TBEN-S: Programming not possible</p> <p>Assign IP address using Turck Service Tool PACTware™, Webserver</p> <p>TBEN-L: Create a program for control tasks using different programming interfaces</p> <p>PROFINET Set device name via software/programming environment: TIA-Portal V13 (S7-1500) TIA-Portal V12 (S7-1200) STEP7 V5.5 (S7-300/400)</p>	<p>HF Parameterization via RFID electronic module</p> <p>UHF Configure basic settings via RFID electronic module Advanced parameterization via read/write head DTM</p>	Adjust any existing functions via read/write head or RFID electronic module

Fig. 4: Compact interfaces: Overview of system levels and programming environments

4.7 HF RFID and UHF RFID Compared

Different factors must be taken into consideration for the use of RFID systems. These are different for HF systems and UHF systems. The following table shows some important factors.

	HF	UHF
Transmission frequency	13.56 MHz (worldwide standard)	860...960 MHz (country specific)
International standards	ISO 15639	ISO 18000-6C/Gen2 ETSI EN 302208
Transmission principle	inductive coupling in the electromagnetic near field	radiated electromagnetic wave in the far field
Range	average, up to approx. 1 m	high, up to several meters
Transmission zone of the read/write head	fixed	adjustable
Field distribution in the operating range	homogeneous magnetic field	normally inhomogeneous electromagnetic field
Speed of data transmission	high	very high
Detection of multiple tags per second (bulk capability)	up to approx. 20 tags	up to approx. 200 tags
Effects and interference from materials	through metal	through metal and liquid (depending on the dielectric constant and liquid content)
Effect of physical environmental conditions (e.g. shielding, reflection, absorption, interruption)	low	high
Memory size of the tags	128 bytes...9 Kbytes	24 bytes...1 Kbytes

Typical air interface

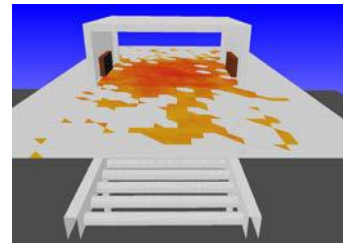
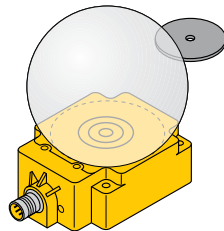

5 System Components

5.1 Modular Interfaces – BL Series

5.1.1 Type Code

Modular Interface Sets in IP20 and IP67

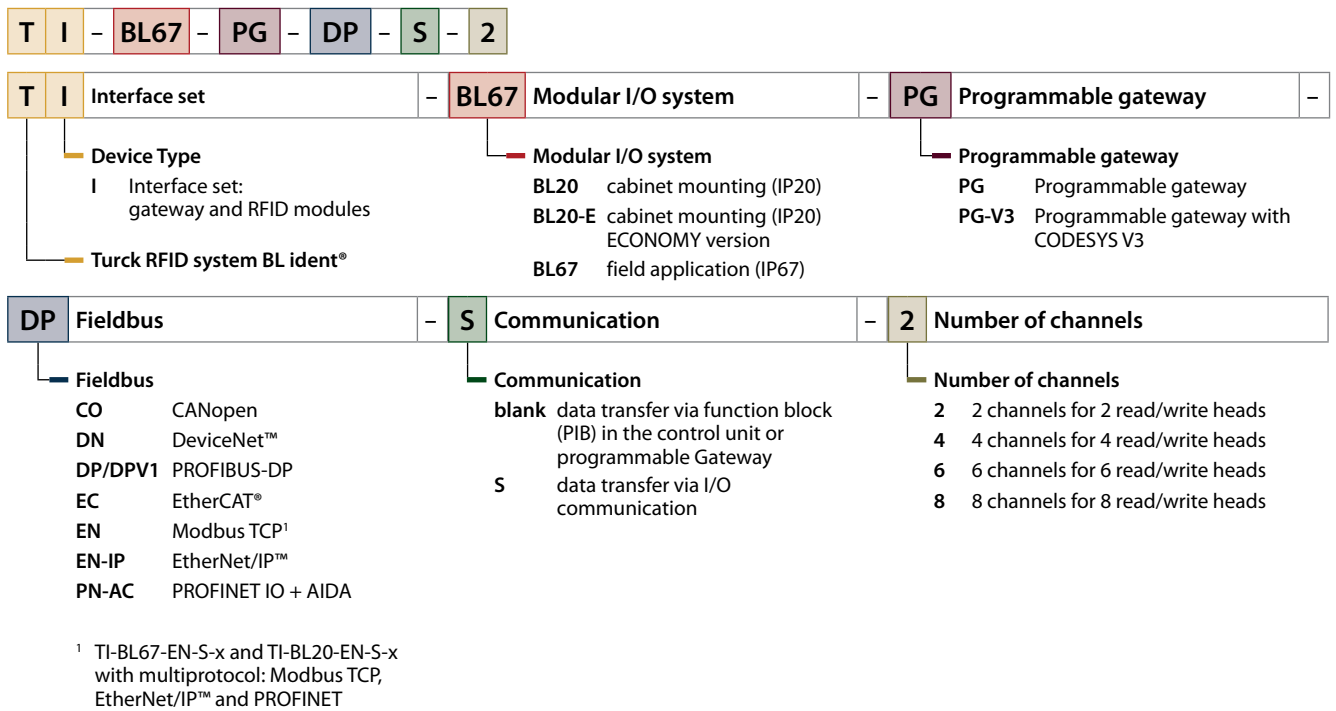

Compact Interfaces in IP67 – BL compact for BL ident®

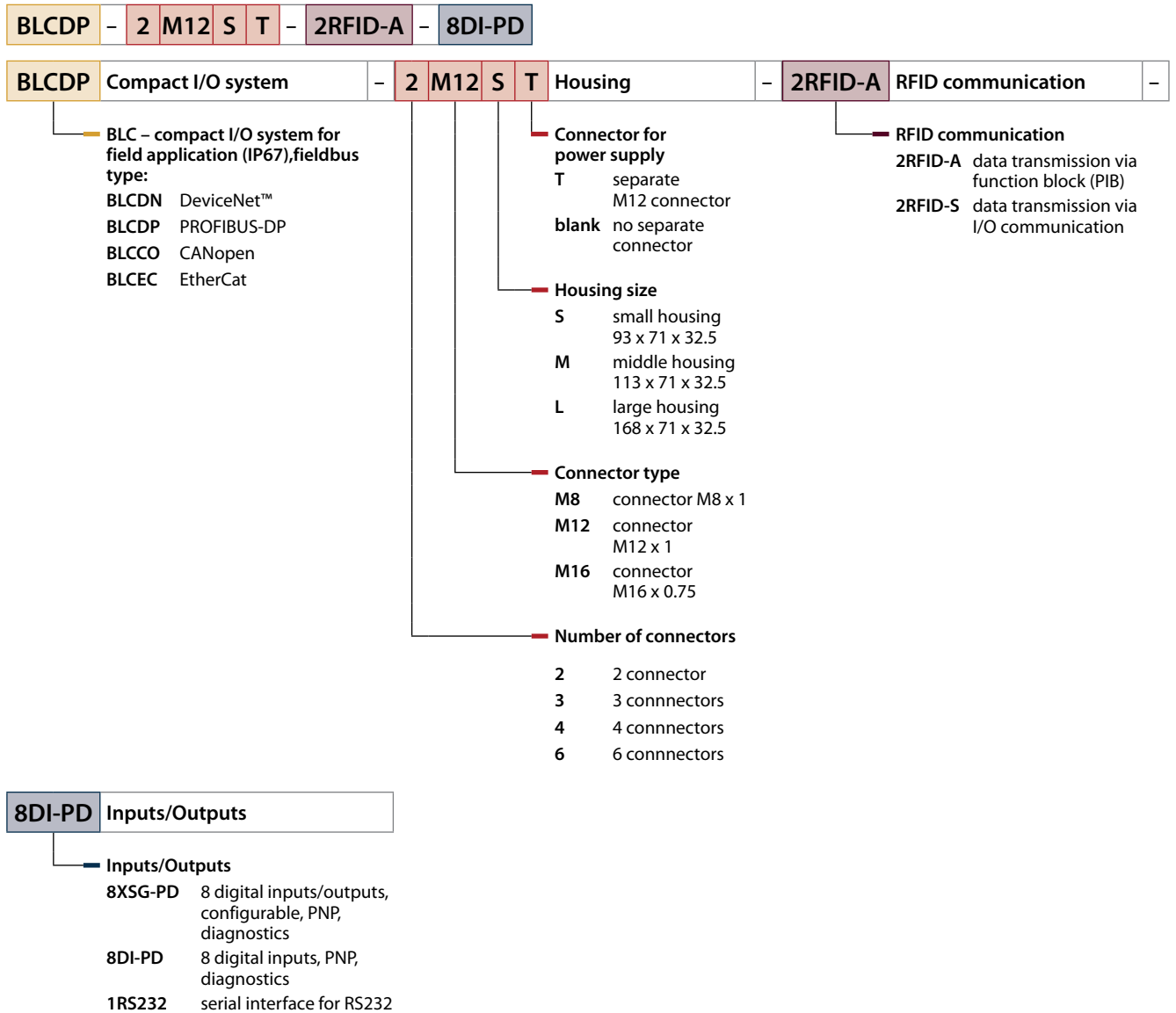

5.1.2 Features

- Interface sets for mounting in the control cabinet (BL20)
- Modular interface sets for mounting directly in the field (BL67)
- Compact interfaces (fieldbus interfaces) with RFID interface and I/Os for mounting in the field (BL compact)
- Interface sets for Ex applications (BL20)
- Fieldbus interface for PROFIBUS-DP, DeviceNet™, CANopen, PROFINET, Modbus TCP, EtherNet/IP™, EtherCAT®
- BL20 and BL67: Up to 16 channels per interface
- CODESYS programmable gateways
- Cable length to the read/write head up to 50 m

5.1.3 Design of BL ident® Interfaces

The BL20 (IP20) and BL67 (IP67) modular interfaces as well as the BL compact (IP67) interfaces are available for the BL ident® system.

The modular interface sets consist of a gateway and one or several RFID modules, which can also be expanded at a later time. Depending on the type of fieldbus up to 16 channels can be fitted. One RFID module each with an electronic module and a base module are required for every two channels.

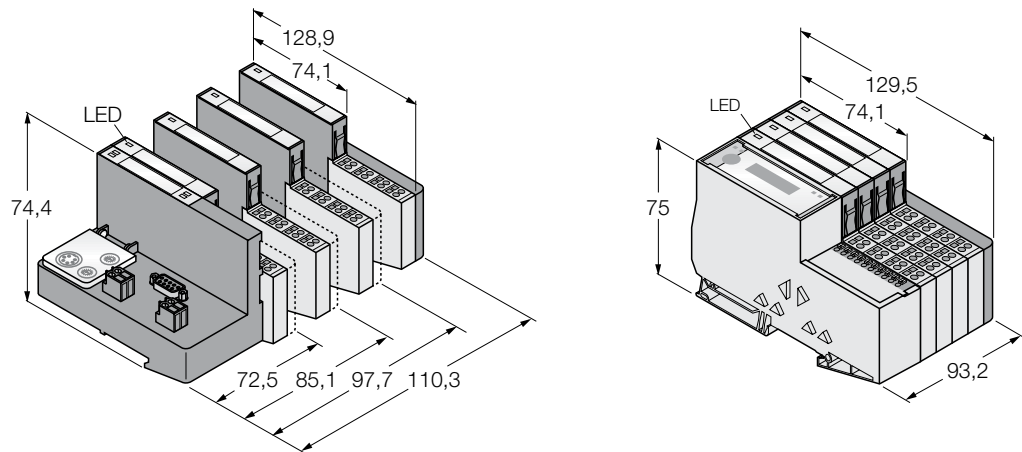

Fig. 5: BL ident® interface sets in IP20 as standard and ECO version (BL20)

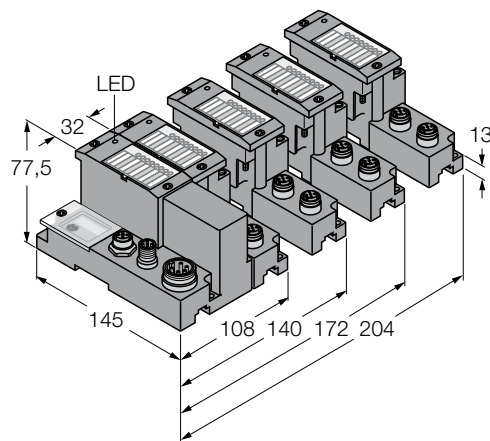

Fig. 6: BL ident® interfaces in IP67 (BL67)

The compact BL compact interfaces combine the functions of gateway and I/O electronics in a fully encapsulated IP67 housing. Interfaces designed exclusively for connecting read/write heads and also for the additional connection of field devices such as sensors or actuators are available.

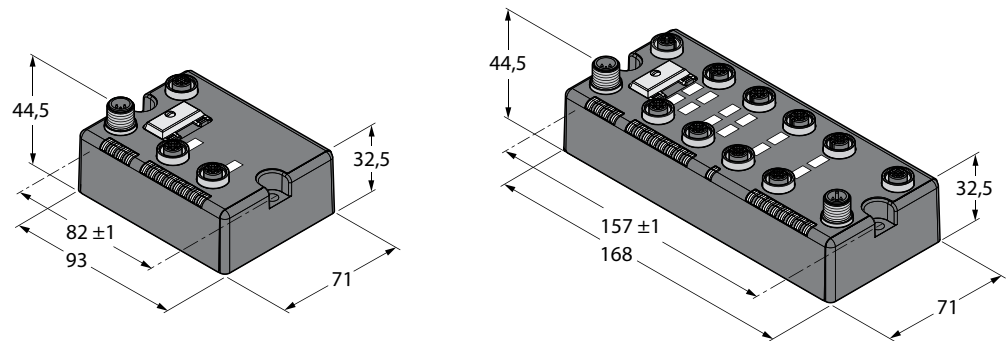

Fig. 7: Compact BL ident® interfaces in IP67 (BL compact)

5.1.4 Operating Principle

The BL ident® interfaces connect the RFID system with the higher-level controller system (PLC or industrial PC). The interfaces are provided with a gateway with a fieldbus interface and fieldbus-independent I/O electronics with an RFID interface. The RFID system is connected to the (existing) fieldbus system via the fieldbus interface; the read/write heads are connected to the interface via the RFID interfaces. Modular expandable interfaces (interface sets) with protection to IP67 (BL67) and IP20 (BL20), as well as compact, non-modular stations with protection to IP67 (BL compact) can be selected.

The gateways are equipped with fieldbus interfaces such as for PROFIBUS-DP, EtherNet/IP™, Modbus TCP, DeviceNet™, PROFINET, CANopen and EtherCAT®. The gateways exchange the process data between the fieldbus and RFID system and also generate diagnostics information for the controller. To relieve the load on the controller, programmable gateways can also be used, which autonomously perform control and diagnostic tasks locally. In this case, the function block required for the control tasks is run in the programmable gateway.

5.1.5 Interface Sets – Gateways (BL20 and BL67)

The gateway connects the RFID modules with the fieldbus and varies according to the fieldbus system used. It handles the entire process data traffic and generates diagnostic information for the higher-level controller as well as for the parameter software. Programmable gateways can also take over autonomous control tasks.

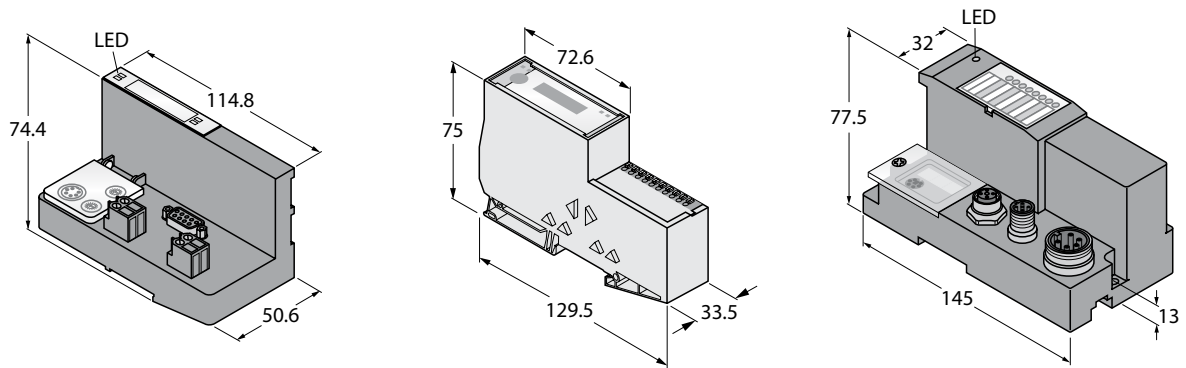

Fig. 8: Gateways for BL20 (standard and ECO version) and BL67, e.g. for PROFIBUS-DP

5.1.6 Interface Sets – RFID Modules (BL20 and BL67)

The RFID modules of the modular BL ident® interface each consist of a passive base module and an RFID electronic module.

The base modules contain the connection technology for field devices such as read/write heads, sensors and actuators. The following base modules are available:

- BL20 system (degree of protection IP20)
 - BL20-S4T-SBBS (cage clamp terminal): for standard and ECO gateways – contained as standard in the BL20 interface sets
 - BL20-S4S-SBBS (screw terminal): only for standard gateways
- BL67 system (degree of protection IP67)
 - BL67-B-2M12 (M12 male connector terminal)



Fig. 9: Base module for BL20 (left) and BL67 (right)

The RFID electronic modules are used as I/O modules. The electronic modules are fitted to the base modules and are independent of the field wiring. During commissioning or maintenance, the electronic modules can be fitted without having to disconnect the field wiring.

The BL ident® system comprises two types of electronic module:

- BLxx-2RFID-S modules (Simple RFID) for simple I/O communication
- BL...-2RFID-A modules (Advanced RFID) for use with function blocks and with programmable gateways

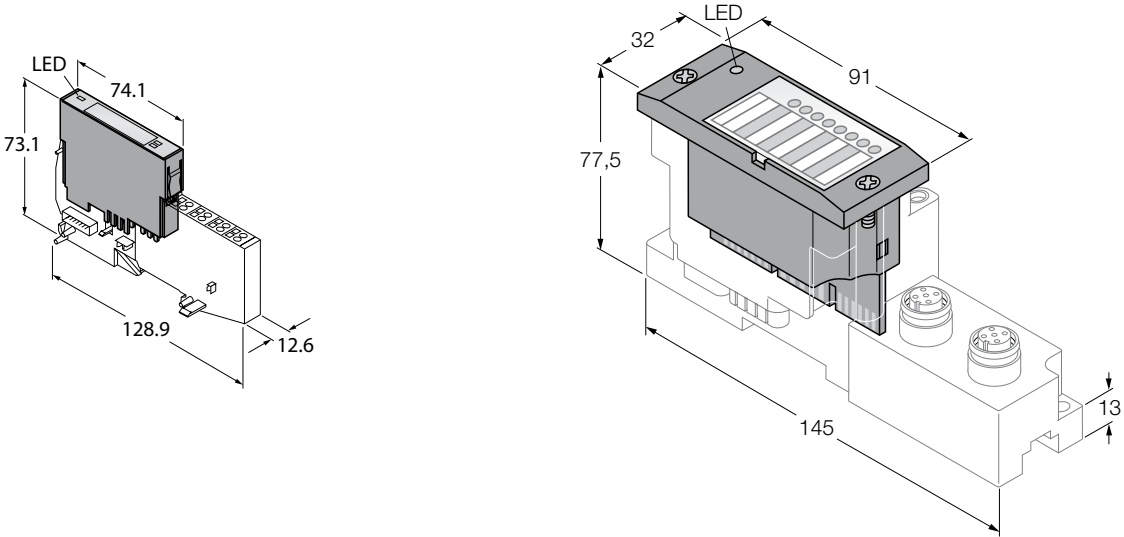

Fig. 10: Electronic module for BL20 (left) and BL67 (right)

5.1.7 Compact Interface – BL compact

The BL compact range includes compact modules with RFID interfaces for connecting read/write heads to the automation infrastructure. The modules are available either as pure 2 or 4-channel RFID blocks or as a combination of a signal group with two RFID channels with a second signal group, e.g. with digital I/O channels for detecting trigger signals or controlling ports (8XSG-PD module).

Functions of BL compact Modules

Compact BL ident® interfaces in IP67 (BL compact)				
Fieldbus	BL ident® interface – type (Gateway + I/O communication)	Function	Type ...2RFID-A:	Type ...2RFID-S:
PROFIBUS-DP	BLCDP-2M12MT-2RFID-A BLCDP-2M12MT-2RFID-S	2 × read/write head	x	x
	BLCDP-6M12LT-2RFID-A-8DI-PD BLCDP-6M12LT-2RFID-S-8DI-PD	2 × read/write head + 2 × digital input	x	x
	BLCDP-6M12LT-2RFID-A-8XSG-PD BLCDP-6M12LT-2RFID-S-8XSG-PD	2 × read/write head + 8 × digital input/output (configurable)	x	x
DeviceNet™	BLCDN-2M12S-2RFID-S	2 × read/write head		x
	BLCDN-4M12L-2RFID-S-2RFID-S	4 × read/write head		x
	BLCDN-6M12LT-2RFID-S-8XSG-PD	2 × read/write head + 8 × digital input/output (configurable)		x
CANopen	BLCCO-2M12S-2RFID-S	2 × read/write head		x
	BLCCO-2M12T-2RFID-S-8XSG	2 × read/write head + 8 × digital input/output (configurable)		x
Multiprotocol: – Modbus TCP – EtherNet/IP™	BLCEN-2M12LT-2RFID-S	2 × read/write head		x
EtherCAT	BLCEC-2M12MT-2RFID-S	2 × read/write head		x

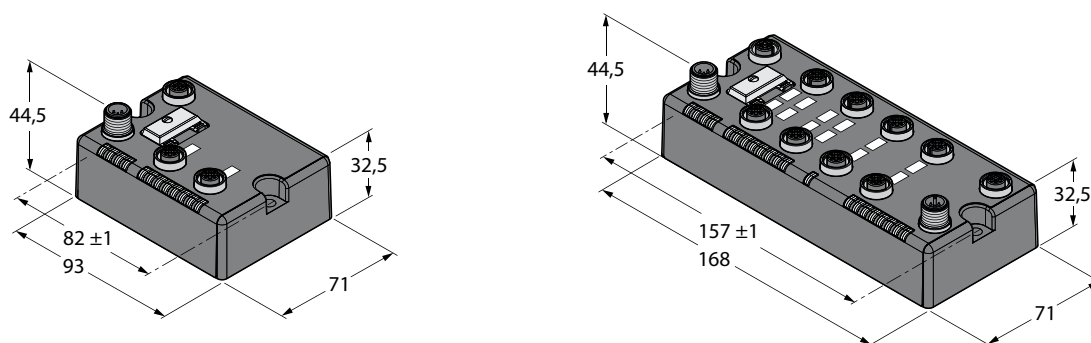

Fig. 11: BL compact modules (example PROFIBUS-DP): only for read/write heads (left) and with additional digital channels (right)

5.1.8 Functions and Operating Modes

BL...-2RFID-S Modules

- Read and write 8 bytes per channel
- Integration possible in any network as the data is treated like I/Os
- Fast processing speed due to low complexity

BL...-2RFID-A Modules

- 16 Kbyte memory per channel for processing large data volumes
- Read and write commands are saved in the module to shorten the reaction time.
- PIB function block for integrating PROFIBUS and PROFINET networks with Siemens CPUs as well as for use with programmable gateways
- Processing of tags up to 9 Kbytes (8 Kbyte user memory)

Firmware Status

The following table describes the current firmware versions of the interfaces (As at: 2017/04)

Device	Firmware version
BL67-2RFID-S	SR51 (available on request)
BL67-2RFID-A	SR51 (available on request)
BL20-2RFID-S	SR51 (available on request)
BL20-2RFID-A	SR51 (available on request)
BL20-GW-DPV1	FW1.28 (available online at www.turck.com)
BL20-E-GW-DP	FW V1.28 (available online at www.turck.com)
BL20-GWBR-DNET	FW V7.18 (available online at www.turck.com)
BL20-E-GW-DN	FW V2.16 (available online at www.turck.com)
BL20-E-GW-CO	FW V5.02 (available online at www.turck.com)
BL20-GW-EN	FW 2.0.5.0 (available online at www.turck.com)
BL20-PG-EN	FW V2.1.3.0 (available online at www.turck.com)
BL20-PG-EN-IP	FW V2.10.0.3 (available online at www.turck.com)
BL20-E-GW-PN	V1.0.0.2 (available online at www.turck.com)
BL20-E-GW-EC	FW V1.1.1.0 (available online at www.turck.com)
BL67-GW-DPV1	FW V1.29 (available online at www.turck.com)
BL67-GW-DN	FW-V7.18 (available online at www.turck.com)
BL67-GW-EN	V3.1.4.0 (available online at www.turck.com)
BL67-PG-EN	FW V2.1.3.0 (available online at www.turck.com)
BL67-PG-EN-IP	FW V2.10.0.3 (available online at www.turck.com)
BL67-GW-EN-PN	FW 1.0.0.7 (available online at www.turck.com)
BLCDP-2M12MT-2RFID-A	V1.01 (available on request)
BLCDP-2M12MT-2RFID-S	V1.01 (available on request)
BLCDP-6M12LT-2RFID-A-8DI-PD	V1.01 (available on request)
BLCDP-6M12LT-2RFID-S-8DI-PD	V1.01 (available on request)
BLCDP-6M12LT-2RFID-A-8XSG-PD	V1.01 (available on request)
BLCDP-6M12LT-2RFID-S-8XSG-PD	V1.01 (available on request)

Device	Firmware version
BLCDN-2M12S-2RFID-S	V1.01 (available on request)
BLCDN-4M12L-2RFID-S-2RFID-S	V1.01 (available on request)
BLCDN-6M12LT-2RFID-S-8XSG-PD	V1.01 (available on request)
BLCCO-2M12S-2RFID-S	V1.01 (available on request)
BLCCO-2M12T-2RFID-S-8XSG	V1.01 (available on request)
BLCEN-1MT12LT-2RFID-S	V1.01 (available on request)

5.1.9 Operating and Indication Elements

The interfaces feature the following indication elements:

LED	Gateways (BL20 and BL67)	RFID electronic mod- ules (BL20 and BL67)	Compact interfaces (BL compact)
Supply voltage	x		
Group and bus fault	x		
Status	x	x	x
Diagnostics	x	x	x

5.1.10 Available Device Types

Other gateways can be combined with RFID electronic modules in addition to the pre-assembled interface sets (see section "Compatible Gateways").

BL67 Interface Sets

Dimension drawing

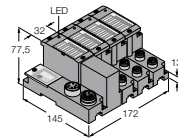
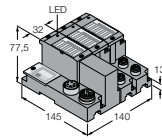
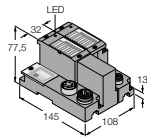

Type	TI-BL67-DN-S-2	TI-BL67-DN-S-4	TI-BL67-DN-S-6
Ident no.	1545114	1545115	1545116
Fieldbus	DeviceNet™	DeviceNet™	DeviceNet™
Number of channels	2	4	6

Dimension drawing

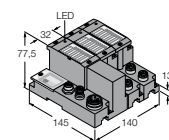
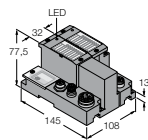
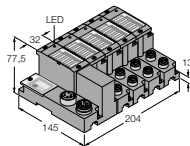

Type	TI-BL67-DN-S-8	TI-BL67-DPV1-2	TI-BL67-DPV1-4
Ident no.	1545117	1545028	1545029
Fieldbus	DeviceNet™	PROFIBUS-DP	PROFIBUS-DP
Number of channels	8	2	4

Dimension drawing

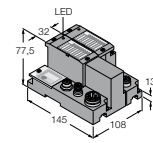
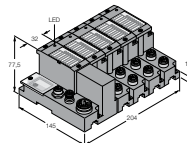
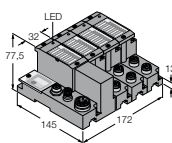

Type	TI-BL67-DPV1-6	TI-BL67-DPV1-8	TI-BL67-DPV1-S-2
Ident no.	1545030	1545031	1545106
Fieldbus	PROFIBUS-DP	PROFIBUS-DP	PROFIBUS-DP
Number of channels	6	8	2

Dimension drawing

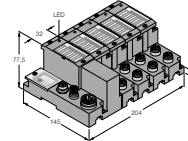
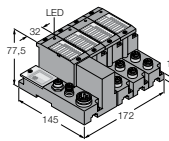
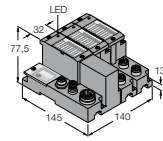

Type	TI-BL67-DPV1-S-4	TI-BL67-DPV1-S-6	TI-BL67-DPV1-S-8
Ident no.	1545107	1545108	1545109
Fieldbus	PROFIBUS-DP	PROFIBUS-DP	PROFIBUS-DP
Number of channels	4	6	8

Dimension drawing

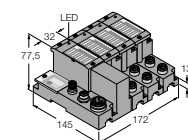
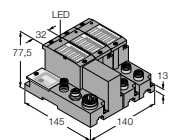
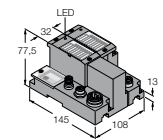

Type	TI-BL67-EN-2	TI-BL67-EN-4	TI-BL67-EN-6
Ident no.	7030610	7030611	7030612
Fieldbus	PROFINET	PROFINET	PROFINET
Number of channels	2	4	6

Dimension drawing

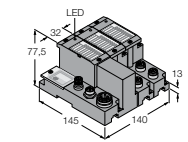
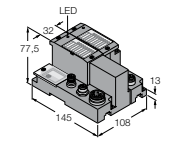
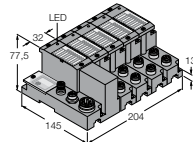

Type	TI-BL67-EN-8	TI-BL67-EN-S-2	TI-BL67-EN-S-4
Ident no.	7030613	1545150	1545151
Fieldbus	PROFINET	Modbus TCP, EtherNet/IP™, PROFINET	Modbus TCP, EtherNet/IP™, PROFINET
Number of channels	8	2	4

Dimension drawing

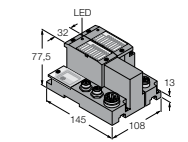
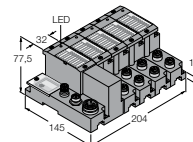
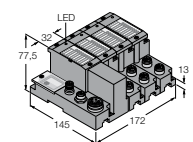

Type	TI-BL67-EN-S-6	TI-BL67-EN-S-8	TI-BL67-PG-DP-2
Ident no.	1545152	1545153	1545061
Fieldbus	Modbus TCP, EtherNet/IP™, PROFINET	Modbus TCP, EtherNet/IP™, PROFINET	PROFIBUS-DP
Number of channels	6	8	2

Dimension drawing

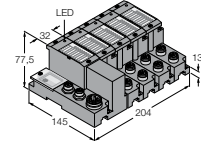
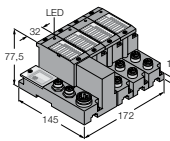
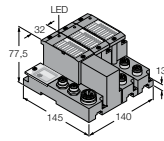

Type	TI-BL67-PG-DP-4	TI-BL67-PG-DP-6	TI-BL67-PG-DP-8
Ident no.	1545062	1545063	1545064
Fieldbus	PROFIBUS-DP	PROFIBUS-DP	PROFIBUS-DP
Number of channels	4	6	8

Dimension drawing

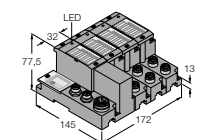
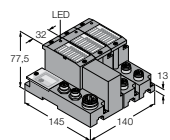
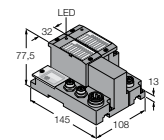

Type	TI-BL67-PG-DP-S-2	TI-BL67-PG-DP-S-4	TI-BL67-PG-DP-S-6
Ident no.	1545094	1545095	1545096
Fieldbus	PROFIBUS-DP	PROFIBUS-DP	PROFIBUS-DP
Number of channels	2	4	6

Dimension drawing

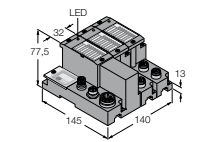
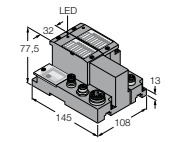
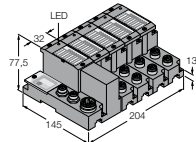

Type	TI-BL67-PG-DP-S-8	TI-BL67-PG-EIP-S-2	TI-BL67-PG-EIP-S-4
Ident no.	1545097	1545102	1545103
Fieldbus	PROFIBUS-DP	EtherNet/IP™	EtherNet/IP™
Number of channels	8	2	4

Dimension drawing

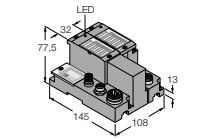
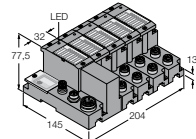
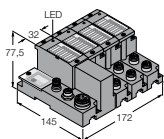

Type	TI-BL67-PG-EIP-S-6	TI-BL67-PG-EIP-S-8	TI-BL67-PG-EN-2
Ident no.	1545104	1545105	1545065
Fieldbus	EtherNet/IP™	EtherNet/IP™	Modbus TCP
Number of channels	6	8	2

Dimension drawing

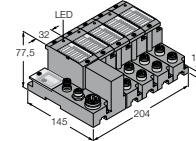
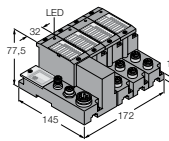
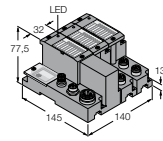

Type	TI-BL67-PG-EN-4	TI-BL67-PG-EN-6	TI-BL67-PG-EN-8
Ident no.	1545066	1545067	1545068
Fieldbus	Modbus TCP	Modbus TCP	Modbus TCP
Number of channels	4	6	8

Dimension drawing

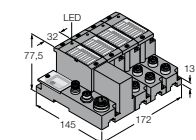
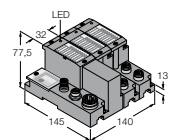
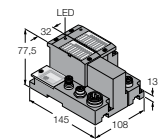

Type	TI-BL67-PG-EN-IP-2	TI-BL67-PG-EN-IP-4	TI-BL67-PG-EN-IP-6
Ident no.	1545069	1545070	1545071
Fieldbus	EtherNet/IP™	EtherNet/IP™	EtherNet/IP™
Number of channels	2	4	6

Dimension drawing

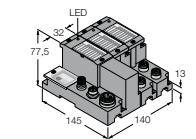
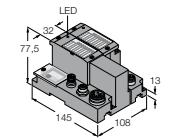
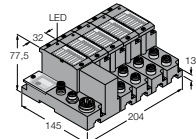

Type	TI-BL67-PG-EN-IP-8	TI-BL67-PG-EN-S-2	TI-BL67-PG-EN-S-4
Ident no.	1545072	1545098	1545099
Fieldbus	EtherNet/IP™	Modbus TCP	Modbus TCP
Number of channels	8	2	4

Dimension drawing

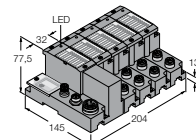
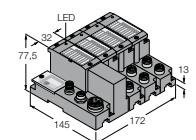

Type	TI-BL67-PG-EN-S-6	TI-BL67-PG-EN-S-8
Ident no.	1545100	1545101
Fieldbus	Modbus TCP	Modbus TCP
Number of channels	6	8

BL67 Interfaces – Compatible Gateways

Dimension drawing

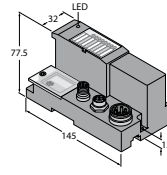
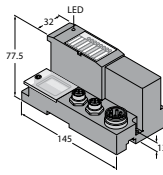
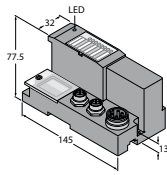

Type	BL67-PG-EN-V3	BL67-PG-EN-V3-WV	BL67-GW-EN-DN
Ident no.	6827394	10000041	6827313
Fieldbus	Multiprotocol: Modbus TCP, EtherNet/IP™, PROFINET	Multiprotocol: Modbus TCP, EtherNet/IP™, PROFINET	Modbus TCP
Applications	PLC systems with Modbus TCP master or PC-based solutions with Modbus driver software, PLC systems with EtherNet/IP™ Scanner (master), PLC systems with PROFINET master	PLC systems with Modbus TCP master or PC-based solutions with Modbus driver software, PLC systems with EtherNet/IP™ Scanner (master), PLC systems with PROFINET master, with WebVisu license	PLC systems with Modbus TCP master or PC-based solutions with Modbus driver software, the gateway is also provided with a DeviceNet™ Scanner (master) for creating a DeviceNet™ sub-bus

Dimension drawing

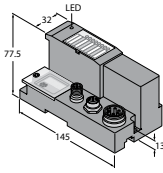
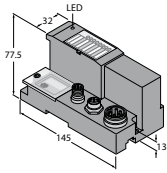

Type	BL67-GW-EN-IP-DN	BL67-GW-CO
Ident no.	6827299	6827200
Fieldbus	EtherNet/IP™	CANopen
Applications	PLC systems with EtherNet/IP™ master, the gateway is also provided with a DeviceNet™ Scanner (master) for creating a DeviceNet™ sub bus	PLC systems with CANopen master

BL20 Interface Sets

Dimension drawing

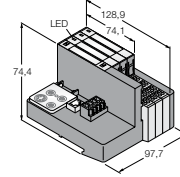
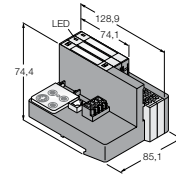
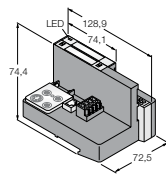

Type	TI-BL20-PG-EN-S-2	TI-BL20-PG-EN-S-4	TI-BL20-PG-EN-S-6
Ident no.	1545086	1545087	1545088
Fieldbus	Modbus TCP	Modbus TCP	Modbus TCP
Number of channels	2	4	6

Dimension drawing

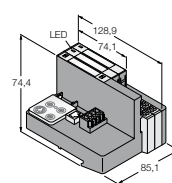
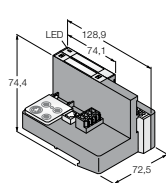
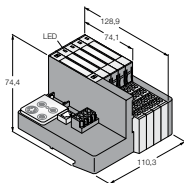

Type	TI-BL20-PG-EN-S-8	TI-BL20-PG-EN-IP-S-2	TI-BL20-PG-EN-IP-S-4
Ident no.	1545089	1545090	1545091
Fieldbus	Modbus TCP	EtherNet/IP™	EtherNet/IP™
Number of channels	8	2	4

Dimension drawing

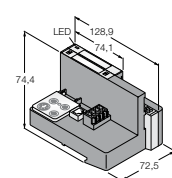
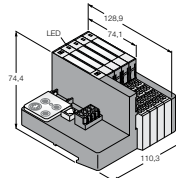
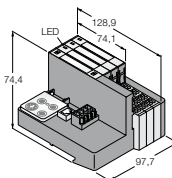

Type	TI-BL20-PG-EN-IP-S-6	TI-BL20-PG-EN-IP-S-8	TI-BL20-PG-EN-IP-2
Ident no.	1545092	1545093	1545057
Fieldbus	EtherNet/IP™	EtherNet/IP™	EtherNet/IP™
Number of channels	6	8	2

Dimension drawing

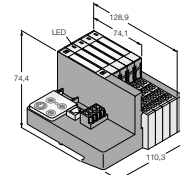
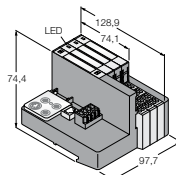
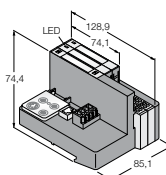

Type	TI-BL20-PG-EN-IP-4	TI-BL20-PG-EN-IP-6	TI-BL20-PG-EN-IP-8
Ident no.	1545058	1545059	1545060
Fieldbus	EtherNet/IP™	EtherNet/IP™	EtherNet/IP™
Number of channels	4	6	8

Dimension drawing

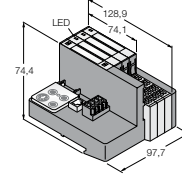
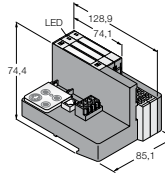
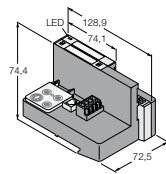

Type	TI-BL20-PG-EN-2	TI-BL20-PG-EN-4	TI-BL20-PG-EN-6
Ident no.	1545053	1545054	1545055
Fieldbus	Modbus TCP	Modbus TCP	Modbus TCP
Number of channels	2	4	6

Dimension drawing

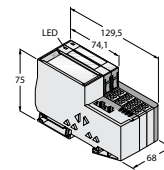
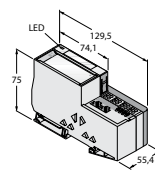
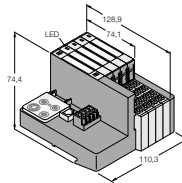

Type	TI-BL20-PG-EN-8	TI-BL20-E-PN-S-2	TI-BL20-E-PN-S-4
Ident no.	1545056	7030471	7030472
Fieldbus	Modbus TCP	PROFINET	PROFINET
Number of channels	8	2	4

Dimension drawing

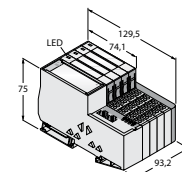
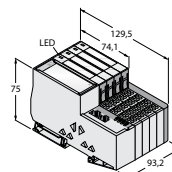
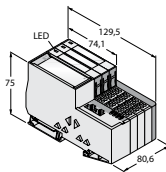

Type	TI-BL20-E-PN-S-6	TI-BL20-E-PN-S-8	TI-BL20-E-PN-8
Ident no.	7030473	7030474	7030470
Fieldbus	PROFINET	PROFINET	PROFINET
Number of channels	6	8	8

Dimension drawing

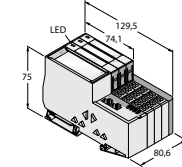
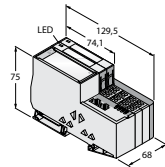
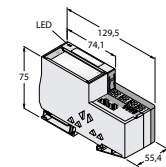

Type	TI-BL20-E-EN-S-2	TI-BL20-E-EN-S-4	TI-BL20-E-EN-S-6
Ident no.	7030630	7030631	7030632
Fieldbus	Modbus TCP, EtherNet/IP™, PROFINET	Modbus TCP, EtherNet/IP™, PROFINET	Modbus TCP, EtherNet/IP™, PROFINET
Number of channels	2	4	6

Dimension drawing

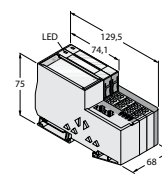
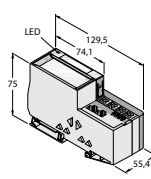
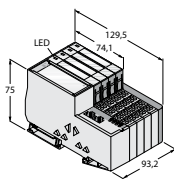

Type	TI-BL20-E-EN-S-8	TI-BL20-E-EN-2	TI-BL20-E-EN-4
Ident no.	7030633	7030614	7030615
Fieldbus	Modbus TCP, EtherNet/IP™, PROFINET	PROFINET	PROFINET
Number of channels	8	2	4

Dimension drawing

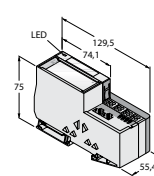
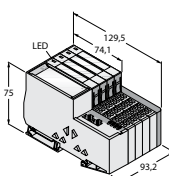
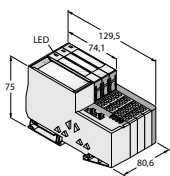

Type	TI-BL20-E-EN-6	TI-BL20-E-EN-8	TI-BL20-E-EC-S-2
Ident no.	7030616	7030617	7030479
Fieldbus	PROFINET	PROFINET	EtherCAT
Number of channels	6	8	2

Dimension drawing

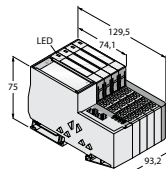
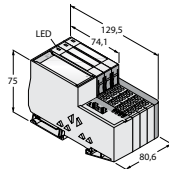
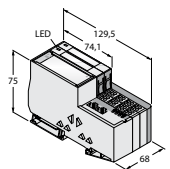

Type	TI-BL20-E-EC-S-4	TI-BL20-E-EC-S-6	TI-BL20-E-EC-S-8
Ident no.	7030480	7030481	7030482
Fieldbus	EtherCAT	EtherCAT	EtherCAT
Number of channels	4	6	8

Dimension drawing

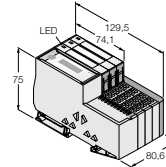
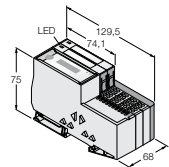
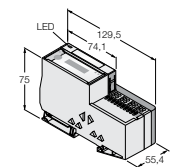

Type	TI-BL20-E-DPV1-S-2	TI-BL20-E-DPV1-S-4	TI-BL20-E-DPV1-S-6
Ident no.	1545126	1545127	1545128
Fieldbus	PROFIBUS-DP	PROFIBUS-DP	PROFIBUS-DP
Number of channels	2	4	6

Dimension drawing

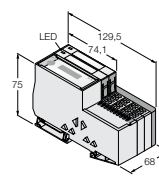
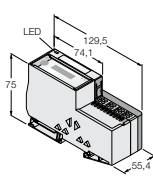
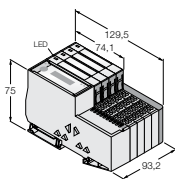

Type	TI-BL20-E-DPV1-S-8	TI-BL20-E-DPV1-2	TI-BL20-E-DPV1-4
Ident no.	1545129	1545122	1545123
Fieldbus	PROFIBUS-DP	PROFIBUS-DP	PROFIBUS-DP
Number of channels	8	2	4

Dimension drawing

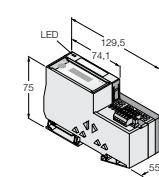
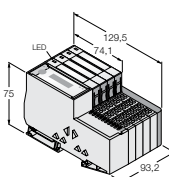
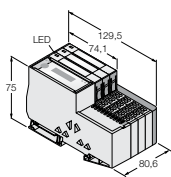

Type	TI-BL20-E-DPV1-6	TI-BL20-E-DPV1-8	TI-BL20-E-DN-S-2
Ident no.	1545124	1545125	1545130
Fieldbus	PROFIBUS-DP	PROFIBUS-DP	DeviceNet™
Number of channels	6	8	2

Dimension drawing

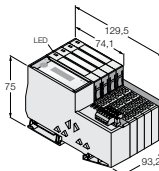
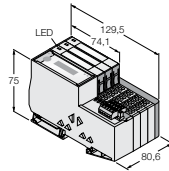
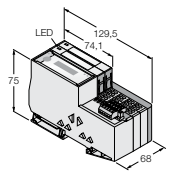

Type	TI-BL20-E-DN-S-4	TI-BL20-E-DN-S-6	TI-BL20-E-DN-S-8
Ident no.	1545131	1545132	1545133
Fieldbus	DeviceNet™	DeviceNet™	DeviceNet™
Number of channels	4	6	8

Dimension drawing

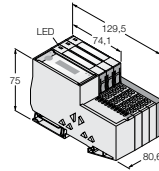
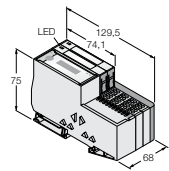
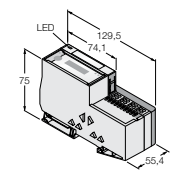

Type	TI-BL20-E-CO-S-2	TI-BL20-E-CO-S-4	TI-BL20-E-CO-S-6
Ident no.	1545134	1545135	1545136
Fieldbus	CANopen	CANopen	CANopen
Number of channels	2	4	6

Dimension drawing

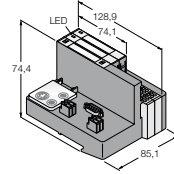
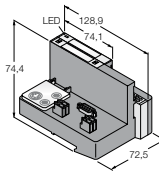
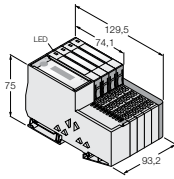

Type	TI-BL20-E-CO-S-8	TI-BL20-DPV1-S-2	TI-BL20-DPV1-S-4
Ident no.	1545137	1545074	1545075
Fieldbus	CANopen	PROFIBUS-DP	PROFIBUS-DP
Number of channels	8	2	4

Dimension drawing

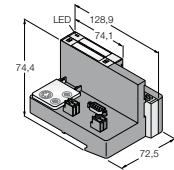
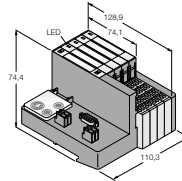
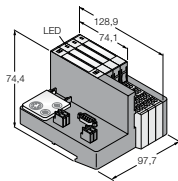

Type	TI-BL20-DPV1-S-6	TI-BL20-DPV1-S-8	TI-BL20-DPV1-2
Ident no.	1545076	1545077	1545004
Fieldbus	PROFIBUS-DP	PROFIBUS-DP	PROFIBUS-DP
Number of channels	6	8	2

Dimension drawing

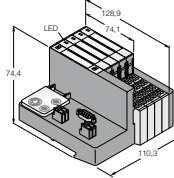
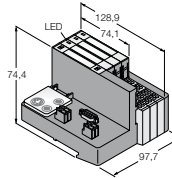
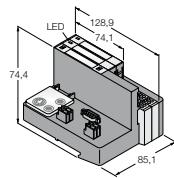

Type	TI-BL20-DPV1-4	TI-BL20-DPV1-6	TI-BL20-DPV1-8
Ident no.	1545005	1545006	1545007
Fieldbus	PROFIBUS-DP	PROFIBUS-DP	PROFIBUS-DP
Number of channels	4	6	8

Dimension drawing

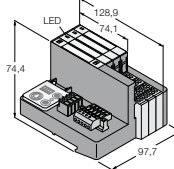
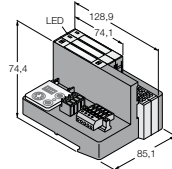
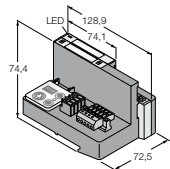

Type	TI-BL20-DN-S-2	TI-BL20-DN-S-4	TI-BL20-DN-S-6
Ident no.	1545078	1545079	1545080
Fieldbus	DeviceNet™	DeviceNet™	DeviceNet™
Number of channels	2	4	6

Dimension drawing

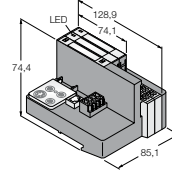
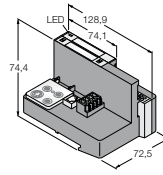
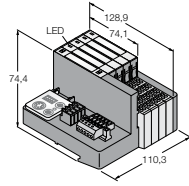

Type	TI-BL20-DN-S-8	TI-BL20-EN-PN-S-2	TI-BL20-EN-PN-S-4
Ident no.	1545081	1545146	1545147
Fieldbus	DeviceNet™	PROFINET	PROFINET
Number of channels	8	2	4

Dimension drawing

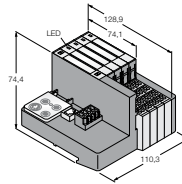
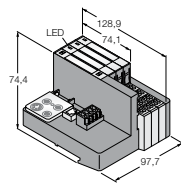

Type	TI-BL20-EN-PN-S-6	TI-BL20-EN-PN-S-8
Ident no.	1545148	1545149
Fieldbus	PROFINET	PROFINET
Number of channels	6	8

BL20 Interfaces – Compatible Gateways

Dimension drawing

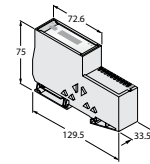
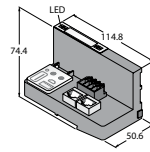
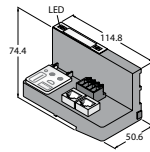

Type	BL20-PG-EN-V3	BL20-PG-EN-V3-WV	BL20-E-GW-RS-MB/ET
Ident no.	6827393	6827398	6827381
Fieldbus	Multiprotocol: Modbus TCP, EtherNet/IP™, PROFINET	Multiprotocol: Modbus TCP, EtherNet/IP™, PROFINET	Modbus TCP/ASCII
Applications	PLC systems with Modbus TCP master or PC-based solutions with Modbus driver software, PLC systems with EtherNet/IP™ Scanner (master), PLC systems with PROFINET master	PLC systems with Modbus TCP master or PC-based solutions with Modbus driver software, PLC systems with EtherNet/IP™ Scanner (master), PLC systems with PROFINET master, with WebVisu license	PLC systems with Modbus RTU/ASCII master

Dimension drawing

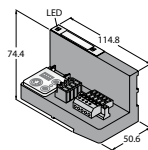

Type	BL20-GWBR-CANOPEN
Ident no.	6827167
Fieldbus	CANopen
Applications	PLC systems with CANopen master

BL compact Interfaces

Dimension drawing

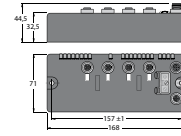
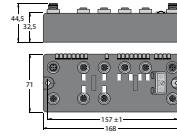
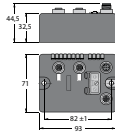

Type	BLCDN-2M12S-2RFID-S	BLCDN-6M12LT-2RFID-S-8XSG-PD	BLCDN-4M12L-2RFID-S-2RFID-S
Ident no.	6811002	6811049	6811055
Fieldbus	DeviceNet™	DeviceNet™	DeviceNet™
Number of channels	2	2/8	2/2

Dimension drawing

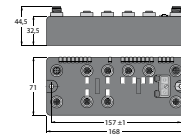
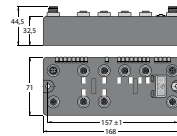
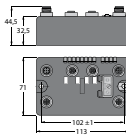

Type	BLCDP-2M12MT-2RFID-A	BLCDP-6M12LT-2RFID-A-8DI-PD	BLCDP-6M12LT-2RFID-A-8XSG-PD
Ident no.	6811166	6811173	6811174
Fieldbus	PROFIBUS-DP	PROFIBUS-DP	PROFIBUS-DP
Number of channels	2	2/8	2/8

Dimension drawing

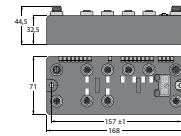
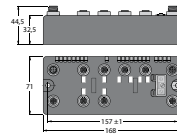
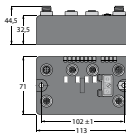

Type	BLCDP-2M12MT-2RFID-S	BLCDP-6M12LT-2RFID-S-8DI-PD	BLCDP-6M12LT-2RFID-S-8XSG-PD
Ident no.	6811177	6811178	6811179
Fieldbus	PROFIBUS-DP	PROFIBUS-DP	PROFIBUS-DP
Number of channels	2	2/8	2/8

Dimension drawing

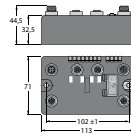
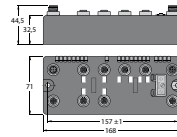
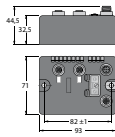

Type	BLCCO-2M12S-2RFID-S	BLCCO-6M12LT-2RFID-S-8XSG-P	BLCEN-2M12MT-2RFID-S
Ident no.	6811300	6811303	6811450
Fieldbus	CANopen	CANopen	Modbus TCP, EtherNet/IP™, PROFINET
Number of channels	2	2/8	2

Dimension drawing

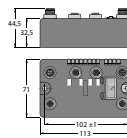
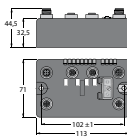

Type	BLCEN-2M12MT-2RFID-A	BLCEC-2M12MT-2RFID-S
Ident no.	6811484	6811630
Fieldbus	Modbus TCP, EtherNet/IP™, PROFINET	EtherCAT
Number of channels	2	2

5.1.11 Possible Combination of Interfaces/Gateways and RFID Modules

The modular design of BL ident® enables a combination of gateways and RFID electronic modules to suit the application. Different functions can be used depending on the combination selected. The following combinations are possible:

Gateway	RFID electronic module	PIB function block
BL...-GW-...	BL...-2RFID-A	for Siemens-CPU S7-300/400, S7-1200, S7-1500, PIB in the controller
BL...-PG-...	BL...-2RFID-A	programmable with CODESYS, PIB in the programmable gateway
BL...-GW-...	BL...-2RFID-S	PIB not necessary, due to simple 8-byte I/O communication

The following tables show the possible combinations of BL20 and BL67 gateways with the relevant RFID modules. Turck offers interface sets with cage clamp terminals or 2, 4, 6 or 8 read/write heads for all combination options.

Combination of BL20 Gateways and RFID Modules

BL ident® Interface (set): Gateway and electronic modules (each with base module) – degree of protection IP20					
Fieldbus	Interface (set) Type x = Number of channels	Gateway Type	Electronic modules		
			Gateway programmable	BL20-2RFID-A PIB function block	BL20-2RFID-S 8-byte I/O communication
PROFIBUS-DP	TI-BL20-DPV1-x	BL20-GW-DPV1		x	
	TI-BL20-DPV1-S-x	BL20-GW-DPV1			x
	TI-BL20-E-DPV1-x	BL20-E-GW-DP		x	
	TI-BL20-E-DPV1-S-x	BL20-E-GW-DP			x
DeviceNet™	TI-BL20-DN-S-x	BL20-GWBR-DNET			x
	TI-BL20-E-DN-S-x	BL20-E-GW-DN			x
CANopen	TI-BL20-E-CO-S-x	BL20-E-GW-CO			x
		BL20-GWBR-CANOPEN			x
Modbus TCP	TI-BL20-E-EN-x	BL20-E-GW-EN			x
	TI-BL20-PG-EN-x	BL20-PG-EN	x	x	
	TI-BL20-PG-EN-S-x	BL20-PG-EN	x		x
EtherNet/IP™	TI-BL20-PG-EIP-x	BL20-PG-EN-IP	x	x	
	TI-BL20-PG-EIP-S-x	BL20-PG-EN-IP	x		x
PROFINET IRT	TI-BL20-E-PN-x	BL20-E-GW-PN		x	
	TI-BL20-E-PN-S-x	BL20-E-GW-PN			x
EtherCAT®	TI-BL20-E-EC-S-x	BL20-E-GW-EC			x
Multiprotocol: PROFINET, Modbus TCP, EtherNet/IP™	TI-BL20-E-EN-x	BL20-E-GW-EN		x (only PROFINET)	
	TI-BL20-E-EN-S-x				x
		BL20-PG-EN-V3	x	x	x
		BL20-PG-EN-V3-WV	x	x	x
Modbus RTU/ ASCII		BL20-E-GW-RS-MB/ET			x

Combination of BL67 Gateways and RFID Modules

BL ident® Interface (set): Gateway and electronic modules (each with base module) – degree of protection IP67						
Fieldbus	Interface (set) Type x = Number of channels	Gateway Type	Gateway programmable	Electronic modules		
				BL67-2RFID-A PIB function block	BL67-2RFID-S 8-byte I/O communication	
Profibus-DP	TI-BL67-DPV1-x	BL67-GW-DPV1		x		
	TI-BL67-DPV1-S-x	BL67-GW-DPV1			x	
	TI-BL67-PG-DP-x	BL67-PG-DP	x	x		
	TI-BL67-PG-DP-S-x	BL67-PG-DP	x		x	
DeviceNet™	TI-BL67-DN-S-x	BL67-GW-DN			x	
CANopen		BL67-GW-CO			x	
Multiprotocol: PROFINET, Modbus TCP, EtherNet/IP™	TI-BL67-EN-S-x	BL67-GW-EN			x	
	TI-BL67-EN-x	BL67-GW-EN		x (only PROFINET)		
		BL67-PG-EN-V3	x	x	x	
		BL67-PG-EN-V3-WV	x	x	x	
Modbus TCP	TI-BL67-PG-EN-x	BL67-PG-EN	x	x		
	TI-BL67-PG-EN-S-x	BL67-PG-EN	x		x	
Modbus TCP slave with integrated DeviceNet™ master		BL67-GW-EN-DN			x	
EtherNet/IP™	TI-BL67-PG-EIP-x	BL67-PG-EN-IP	x	x		
	TI-BL67-PG-EIP-S-x	BL67-PG-EN-IP	x		x	
EtherNet/IP™ slave with integrated DeviceNet™ master		BL67-GW-EN-IP-DN			x	
PROFINET + AIDA connection technology	TI-BL67-PN-AC-x	BL67-GW-EN-AC		x		
	TI-BL67-PN-AC-S-x	BL67-GW-EN-AC			x	

PIB Function Block – Variants and Programming Environment

Software	CODESYS V2	CODESYS V3	STEP7 V5.5	S7-TIA Portal V12	S7-TIA Portal V13	S7-TIA Portal V14
Hardware	RFID-A	RFID-A	RFID-A	RFID-A	RFID-A	RFID
BL...-PG-xx	x	–	–	–	–	–
BL...	–	x	–	–	–	–
S7-300/400 CPU	–	–	x	x	x	x
S7-1200 CPU	–	–	–	x	x	x
S7-1500 CPU	–	–	–	x	x	x

Selection Aid for the Interface Sets

Criterion	Combination			
	BL...-GW-... BL...-2RFID-A	BL...-GW-... BL...-2RFID-S	BL...-PG-... BL...-2RFID-A	BL...-PG-... BL...-2RFID-S
Siemens CPU	recommended	possible with ≤ 8 bytes per command (alternatively: several commands for transferring all data)	possible (for relieving the central controller)	possible
CPU of other manufacturers	not possible	possible with ≤ 8 bytes per command (alternatively: several commands for transferring all data)	possible	possible
fast data transmission in movement	possible depending on parameters	recommended depending on parameters	possible	recommended
≤ 8 bytes per command	only recommended with Siemens CPU	recommended	possible	possible
> 8 bytes per command	only possible with Siemens CPU	possible with sufficient dwell time (multiple commands required for data transmission)	recommended	possible
Single tag (single detection)	only possible with Siemens CPU	possible	possible	possible
Multitag (bulk reading)	only possible with Siemens CPU	not possible	possible	not possible
Lock block (write protection of a specific block on the tag)	only possible with Siemens CPU	possible	possible	possible
Tune transmitter (Tune read/write head to ambient conditions)	only possible with Siemens CPU	possible	possible	possible
Password function	only possible with Siemens CPU	possible	possible	possible

5.1.12 Accessories

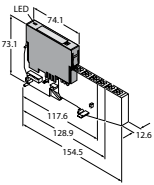
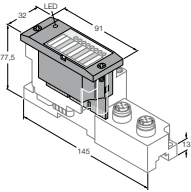
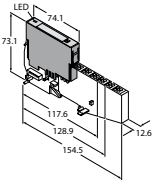
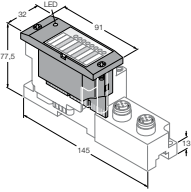
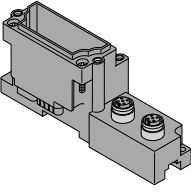
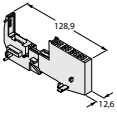
Dimension drawing	Type	Ident no.	Description
	BL20-2RFID-S	6827306	BL ident® RFID electronic module
	BL67-2RFID-S	6827305	BL ident® RFID electronic module
	BL20-2RFID-A	6827233	BL ident® RFID electronic module
	BL67-2RFID-A	6827225	BL ident® RFID electronic module
	BL67-B-2M12	6827186	Used for RFID, 4 DI, 4 DO, AI and AO with 2 × M12 connections
	BL20-S4T-SBBS	6827046	Used for RFID electronic module 4DI, AI (apart from Thermo), 2DO-R and 1CNT, with cage clamp terminal

5.2 Compact Multiprotocol Interfaces – TBEN Series

5.2.1 Type Code

Compact Multiprotocol Interfaces

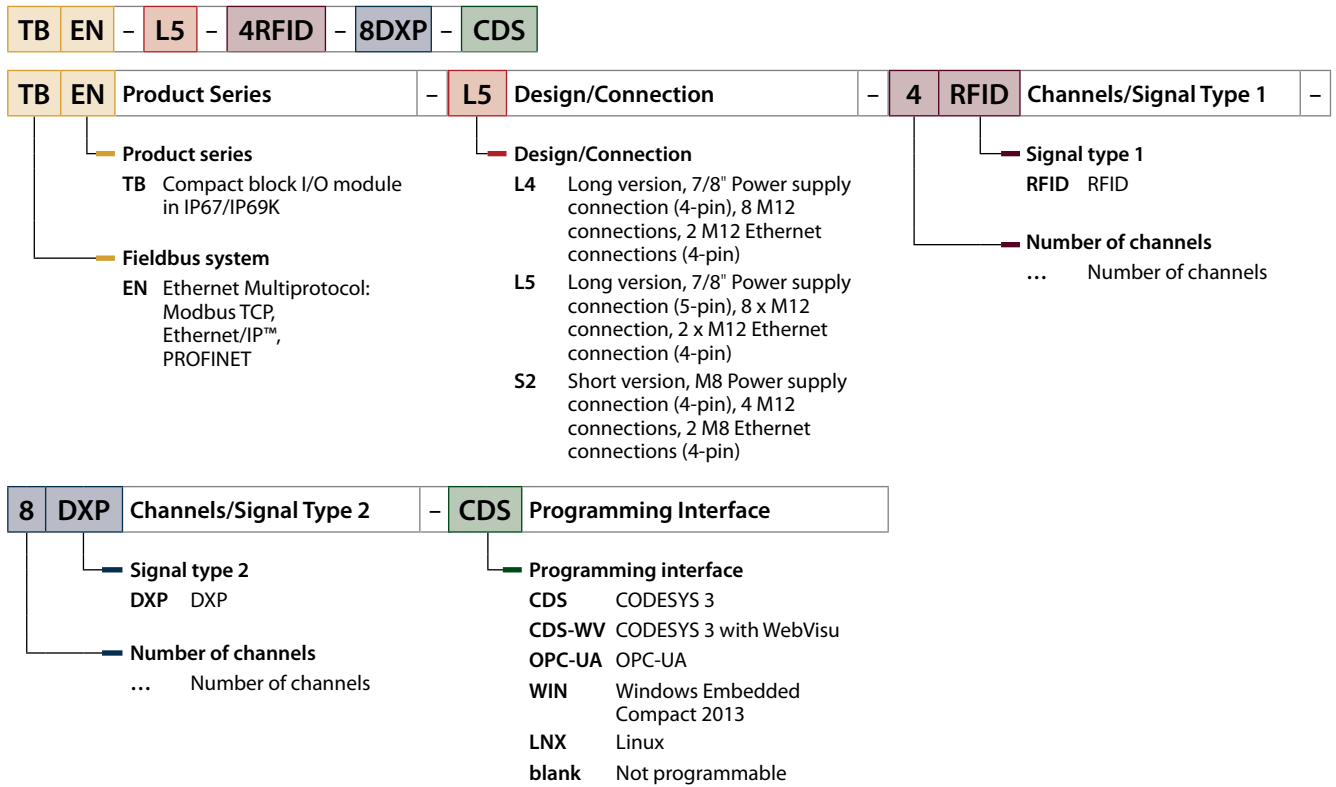

5.2.2 Features

TBEN-S Modules (TBEN-S2-2RFID-4DXP)

- Glass fiber reinforced housing
- Shock and vibration proof
- Fully encapsulated module electronics
- Degree of protection IP65/IP67/IP69K
- Multiprotocol: EtherNet/IP™ Device, Modbus TCP Slave or PROFINET Device
- Integration in the PLC systems without function block
- Up to 128 bytes of user data per write or read cycle per channel, as well as use of fragmentation for larger data volumes
- Data interface for convenient use of RFID functions
- 4-pin M8 plug connector for the power supply
- Two 4-pin M8 connections for Ethernet
- Two channels with M12 connection for RFID
- Four configurable digital channels as 0.5 A pnp inputs or outputs
- Integrated Ethernet switch enables linear topology
- Transmission rate 10 Mbps/100 Mbps
- Integrated web server
- LED indication and diagnostics

TBEN-L Modules (TBEN-L...-4RFID-8DXP-CDS)

- Glass fiber reinforced housing
- Shock and vibration proof
- Fully encapsulated module electronics
- Degree of protection IP65/IP67/IP69K
- Multiprotocol: EtherNet/IP™ Device, Modbus TCP Master, Modbus TCP Slave or PROFINET-RT Device
- Programmable according to IEC 61131-3 with CODESYS V3 to execute controller operations and data prefiltering
- Up to 128 bytes of user data per write or read cycle per channel, as well as use of fragmentation for larger data volumes
- Data interface for convenient use of RFID functions
- 4 or 5-pin 7/8" plug connector for the power supply
- Two 4-pin M12 connections for Ethernet
- Four channels with M12 connection for RFID
- Eight configurable digital channels as 2 A pnp inputs or outputs
- Integrated Ethernet switch enables linear topology
- Transmission rate 10 Mbps/100 Mbps
- Integrated web server
- LED indication and diagnostics

5.2.3 Design of TBEN Interfaces

The TBEN-S... (short design) and TBEN-L... (long design) compact multiprotocol interfaces are available for the BL ident® system. The compact interfaces are implemented in a fully encapsulated plastic housing with degree of protection IP65/IP67/IP69K. Depending on the type of interface, up to four RFID channels and eight digital channels can be used.

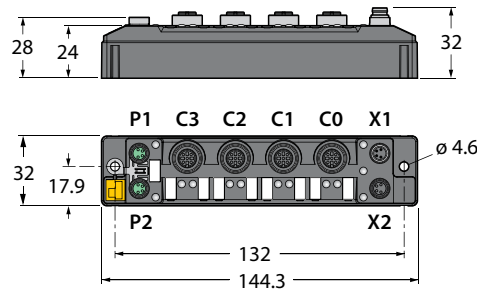

Fig. 12: TBEN-S... compact block module

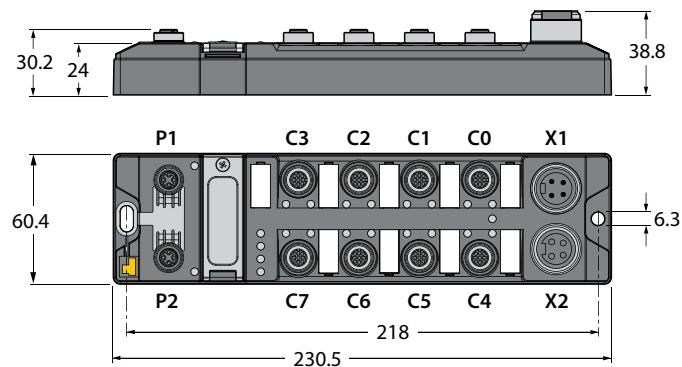

Fig. 13: TBEN-L... compact block module

5.2.4 Operating Principle

The BL ident® interfaces connect the RFID system with the higher-level controller system. The interfaces are provided with a fieldbus interface and fieldbus-independent I/O electronics with an RFID interface. The interfaces can also process sensor and actuator signals via configurable digital channels.

The TBEN interfaces are equipped with a multiprotocol fieldbus interface for Modbus TCP, EtherNet/IP™ and PROFINET. The fieldbus links the RFID system to an (existing) fieldbus system as an EtherNet/IP™ device, Modbus TCP slave or PROFINET device. During operation, the process data is exchanged between the fieldbus and RFID system and diagnostics information is also generated for the controller. The read/write heads are connected to the interfaces via the RFID interfaces.

5.2.5 Functions and Operating Modes

TBEN-S Modules

The compact RFID interfaces transfer data between the RFID level (read/write head and tag) and the controller level. HF and UHF read/write heads can be connected to the RFID channels. Parallel operation of HF and UHF read/write heads on the same device is also possible. The devices can be used as slaves in the PROFINET, EtherNet/IP™ and Modbus TCP fieldbus systems.

The device enables different commands, such as Inventory (single tag and multitag applications), Read, Write and Password protection to be executed. Additional functions are provided for optimizing the speed, the self triggering of the system, as well as for backup and restore operations. With each write or read cycle, 128 bytes can be transferred to the controller for each channel. The module fragments the data in order to transfer more than 128 bytes.

Sensors and actuators can be connected to the configurable digital channels. In all, up to four 3-wire PNP sensors or four PNP DC actuators with a maximum output current of 0.5 A per input or output can be connected.

TBEN-L Modules

The compact RFID interfaces transfer data between the RFID level (read/write head and tag) and the controller level. HF and UHF read/write heads can be connected to the four RFID channels. Parallel operation of HF and UHF read/write heads on the same device is also possible. The devices can be used as slaves in the PROFINET, EtherNet/IP™ and Modbus TCP fieldbus systems. The devices can also be used as masters in the Modbus TCP fieldbus system.

The device enables different commands, such as Inventory (single tag and multitag applications), Read, Write and Password protection to be executed. Additional functions are provided for optimizing the speed, the self triggering of the system, as well as for backup and restore operations. With each write or read cycle, 128 bytes can be transferred to the controller for each channel. The module fragments the data in order to transfer more than 128 bytes.

Sensors and actuators can be connected to the configurable digital channels. Up to eight 3-wire PNP sensors or four PNP DC actuators with a maximum output current of 2 A per output can be connected.

The device can perform autonomous controller and diagnostics functions in order to reduce the workload of the controller. The devices can be programmed with CODESYS 3 according to IEC 61131-3.

HF Bus Mode for TBEN Modules

The compact TBEN-S2-2RFID-4DXP and TBEN-L...-4RFID-8DXP multiprotocol interfaces can be operated in HF bus mode.

Up to 32 bus-capable read/write heads can be run on the device in HF bus mode. An additional power supply is required depending on the number of connected read/write heads. It is therefore necessary to carry out a power consumption analysis of the connected read/write heads. Every connected read/write head supplies a "tag present" signal in HF bus mode. HF bus mode can only be used for static applications because a command can only be processed by one read/write head.

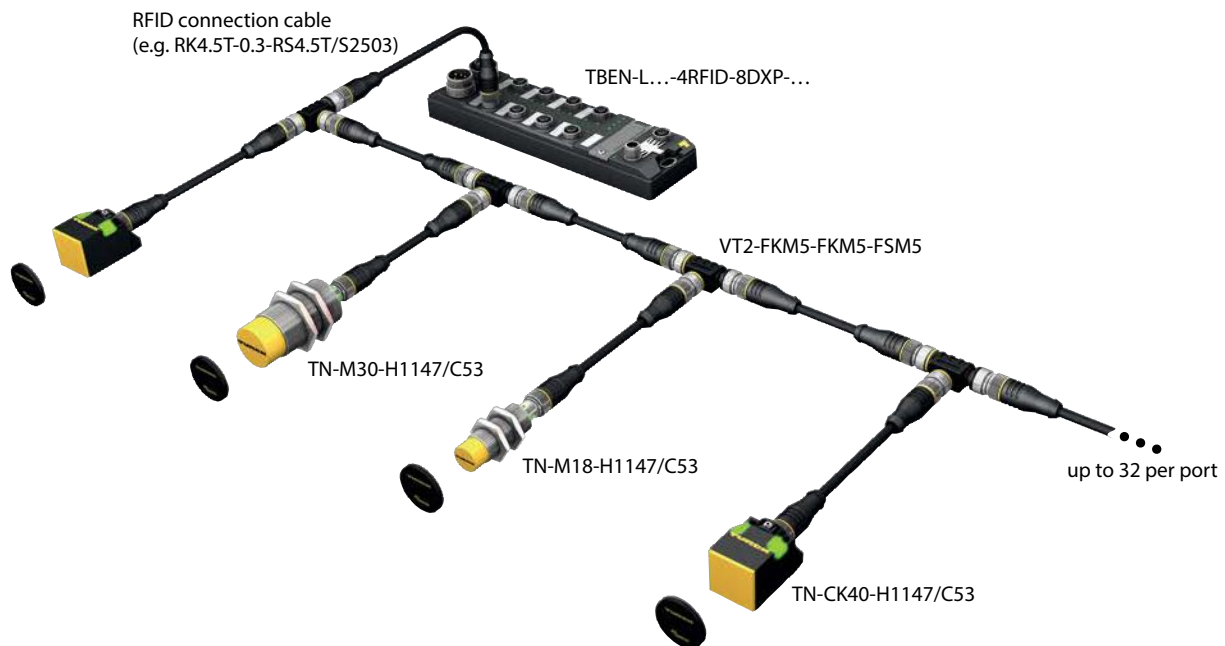

Fig. 14: HF bus mode setup

The following read/write heads can be used for HF bus mode:

- TN-M18-H1147/C53
- TB-M18-H1147/C53
- TN-M30-H1147/C53
- TB-M30-H1147/C53
- TN-CK40-H1147/C53
- TNSLR-Q42TWD-H1147/C53
- TB-Q08-0.15-RS4.47T/C53
- TN-Q14-0.15-RS4.47T/C53

HF bus mode supports the HF read/write heads from firmware version Vx.90.

TBEN-L Modules for System Integrators

The compact TBEN-L...-WIN and TBEN-L...-LNX RFID interfaces are designed for commissioning through system integrators. The interfaces are based on the Windows Embedded Compact 2013 (TBEN-...-WIN) or Linux (TBEN-...-LNX) operating systems. The interfaces are freely programmable; middleware functions can be integrated on the devices. This enables the devices to carry out functions such as filtering and data processing. The data is transferred to higher-level ERP or MES systems via TCP/IP.

For example, the freely programmable interfaces can be used to fully replace IPCs in applications.

Functions of TBEN Modules

Compact multiprotocol interfaces					
Fieldbus	Interface – Type	Function	Operating system or programming interface	Connection for the power supply voltage	Ethernet terminals
Multiprotocol: PROFINET, Modbus TCP and EtherNet/IP™	TBEN-S2-2RFID-4DXP	2 × read/write head 4 × digital sensors or actuators	–	M8 × 1	M8 × 1
	TBEN-L4-4RFID-8DXP-CDS	4 × read/write head 8 × digital sensors or actuators	CODESYS 3	7/8", 4-pin	M12 × 1
	TBEN-L5-4RFID-8DXP-CDS	4 × read/write head 8 × digital sensors or actuators	CODESYS 3	7/8", 5-pin	M12 × 1
	TBEN-L5-4RFID-8DXP-CDS-WV	4 × read/write head 8 × digital sensors or actuators	CODESYS 3 with WebVisu	7/8", 5-pin	M12 × 1
	TBEN-L5-4RFID-8DXP-LNX (in development)	4 × read/write head 8 × digital sensors or actuators	Linux	7/8", 5-pin	M12 × 1
	TBEN-L5-4RFID-8DXP-OPC-UA (in development)	4 × read/write head 8 × digital sensors or actuators	platform-independent (OPC-UA)	7/8", 5-pin	M12 × 1
	TBEN-L5-4RFID-8DXP-WIN	4 × read/write head 8 × digital sensors or actuators	Windows Embedded	7/8", 5-pin	M12 × 1

Firmware Status

The following table describes the current firmware versions of the interfaces (as at: 2017/04).

Device	Firmware version
TBEN-S2-2RFID-4DXP	3.2.2.0 (available online at www.turck.com)
TBEN-L...	1.0.1.0 (available online at www.turck.com)

5.2.6 Operating and Indication Elements

The devices are provided with multi-color LEDs for displaying information:

- Supply voltage
- Group and bus fault
- Status
- Diagnostics

5.2.7 Available Device Types

Dimension drawing

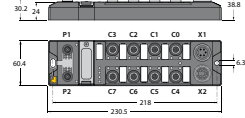
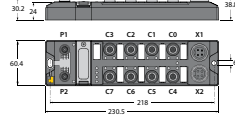
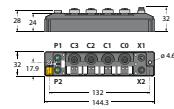

Type	TBEN-S2-2RFID-4DXP	TBEN-L4-4RFID-8DXP-CDS	TBEN-L5-4RFID-8DXP-CDS
Ident no.	6814029	6814121	6814120
Fieldbus	Multiprotocol: PROFINET, Modbus TCP and EtherNet/IP™	Multiprotocol: PROFINET, Modbus TCP and EtherNet/IP™	Multiprotocol: PROFINET, Modbus TCP and EtherNet/IP™
Number of channels	2 RFID channels 4 digital channels	4 RFID channels 8 digital channels	4 RFID channels 8 digital channels
Programmable	no	Yes	Yes

Dimension drawing

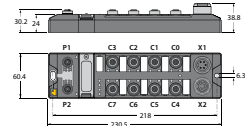
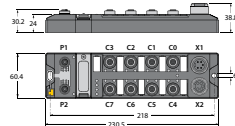
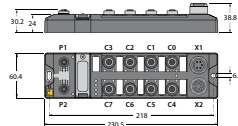

Type	TBEN-L5-4RFID-8DXP-CDS-WV	TBEN-L5-4RFID-8DXP-LNX	TBEN-L5-4RFID-8DXP-OPC-UA
Ident no.	10000960	6814124	6814126
Fieldbus	Multiprotocol: PROFINET, Modbus TCP and EtherNet/IP™		
Number of channels	4 RFID channels 8 digital channels	4 RFID channels 8 digital channels	4 RFID channels 8 digital channels
Programmable	Yes	Yes	Yes
Special features	For system integrators	For system integrators	

Dimension drawing

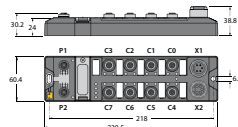

Type	TBEN-L5-4RFID-8DXP-WIN
Ident no.	6814122
Fieldbus	
Number of channels	4 RFID channels 8 digital channels
Programmable	Yes
Special features	For system integrators

5.3 HF Read/Write Heads

5.3.1 Type Codes

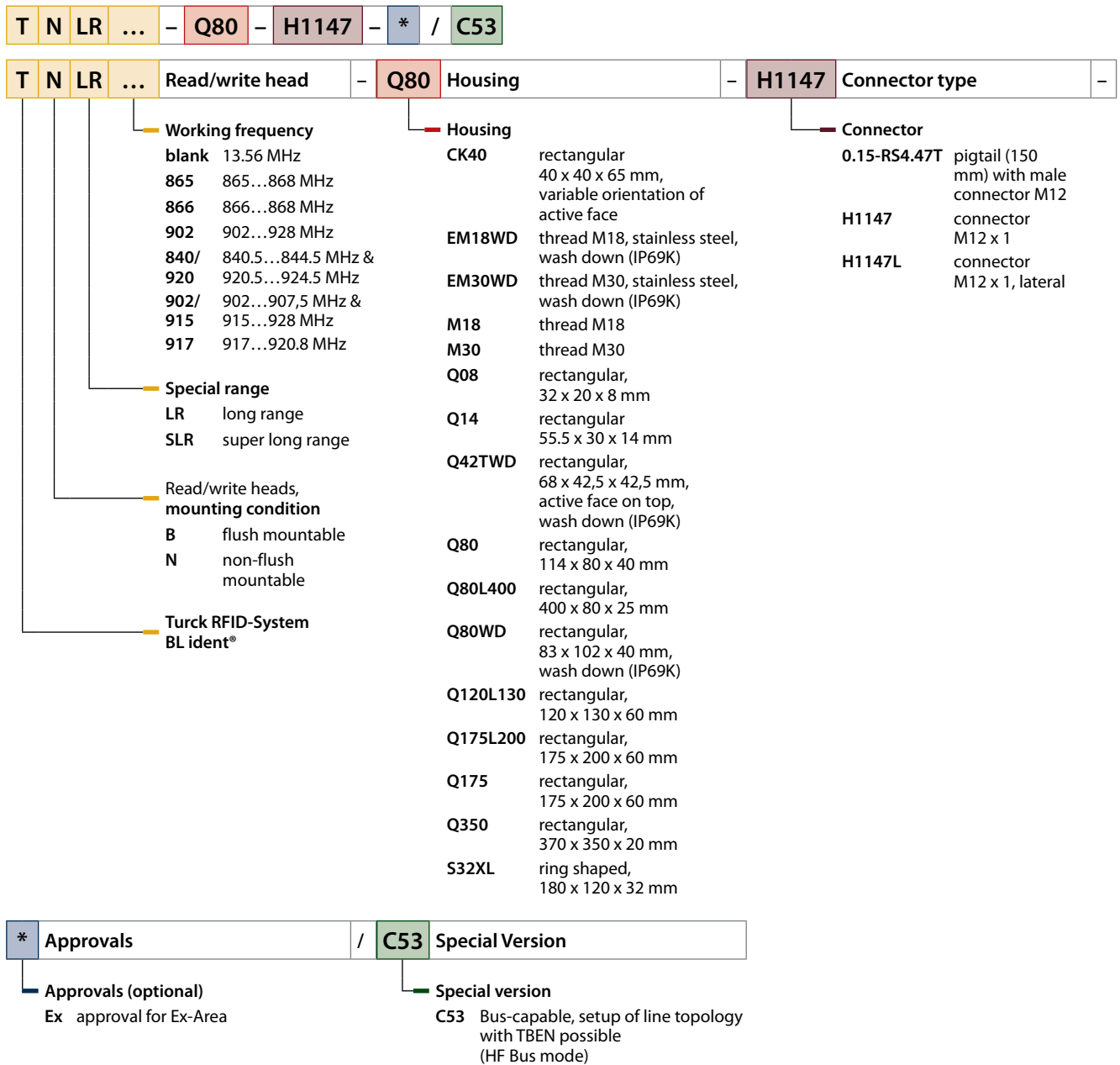

5.3.2 Features of the HF Read/Write Heads

- Fully encapsulated and robust read/write heads
- Variants in rectangular and cylindrical designs
- Read/write heads also for Ex applications (ATEX) and food applications (wash-down, IP69K)
- Read/write distances depending on ambient conditions up to 1000 mm

5.3.3 Setup of the HF Read/Write Heads

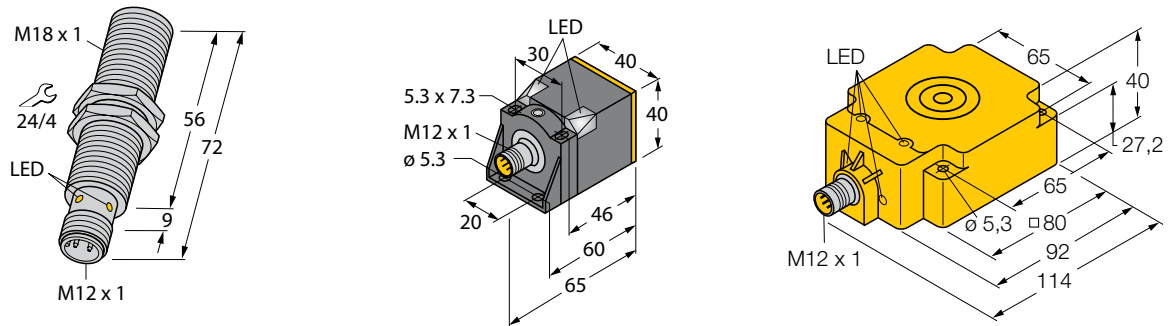

Fig. 15: Setup of HF read/write heads (examples: M18, CK40, Q80 designs)

5.3.4 Operating Principle

The read/write heads are used for contactless data exchange with tags. For this the controller sends commands and data via the interface to the read/write head and receives the corresponding response data from the read/write head. The reading of the IDs of all RFID tags in the read area or the writing of an RFID tag with a specific production date are examples of typical commands. To communicate with the tag, the data of the read/write head is coded and transferred via an electromagnetic field, which at the same time supplies the tags with power.

A read/write head contains a transmitter and a receiver, an interface to the interface and a coupling element (coil and dipole antenna) for communicating with the tag. Inductive coupling is used with devices for the HF range and electromagnetic wave propagation is used for the UHF range as the transmission procedure between read/write head and tag.

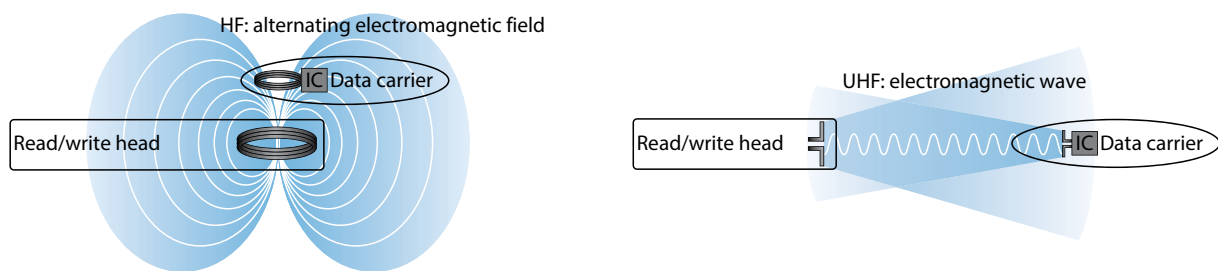

Fig. 16: HF RFID (left) and UHF RFID (right) operating principles

The coupling element of the read/write head generates an alternating electromagnetic field (HF) and electromagnetic waves (UHF). This produces a transmission window as a so-called air interface in which the data exchange with the tag takes place. The size of the transmission window depends on the combination of read/write head and tags, and with UHF on the relevant ambient conditions.

Each BL ident® read/write head can communicate with a number of BL ident® tags. This requires the read/write head and the tag to operate in the same frequency range. The detection ranges of the devices – depending on power and frequency – vary from a few millimeters to several meters. The specified maximum read/write distances only represent typical values under laboratory conditions without allowing for the effect of materials. The achievable distances may be different due to component tolerances, mounting location in the application, ambient conditions and the effect of materials (particularly metal and liquids).

5.3.5 Functions and Operating Modes

Special Function – Automatic Tuning (only with TNLR-... and TNSLR-...)

Type TNLR-... and TNSLR-... read/write heads feature the “Automatic tuning” function. After power up, the read/write head checks whether its resonance frequency is affected by metal in the environment. If there is an effect caused by metal, the oscillating circuit adjusts its frequency to restore the optimum resonance frequency. If the effect caused by metal is too high, the read/write head can no longer tune the resonance frequency. The metal takes too much energy from the field; due to the reduce range communication between the read/write head and the tag is no longer possible.

Firmware Status

The following table describes the current firmware versions of the HF read/write heads (as at: 2016/02).

...H1147 read/write head	Firmware version (available on request)
TB-M18-H1147	1v90
TN-M18-H1147	
TB-M30-H1147	
TN-M30-H1147	
TN-CK40-H1147	
TN-S32XL-H1147	
TN-Q80-H1147	
TN-Q14-0.15-RS4.47T	
TB-EM18WD-H1147	
TN-EM18WD-H1147	
TB-EM30WD-H1147	
TN-EM30WD-H1147	
TN-Q08-0.15-RS4.47T	
HT-IDENT-H1147	
TN-Q80-H1147-EX	
TB-EM18WD-H1147-EX	
TN-EM18WD-H1147-EX	
TB-EM30WD-H1147-EX	
TN-EM30WD-H1147-EX	
TNLR-Q80-H1147	
TNLR-Q80-H1147-EX	
TNLR-Q80L400-H1147	5v90
TNLR-Q80L400-H1147L	
TNSLR-Q42-H1147	7v90_SLR-Q42
TNSLR-Q350-H1147	7v90_SLR-Q350

5.3.6 Operating and Indication Elements

Depending on the device type, the HF read/write heads are provided with different LEDs, e.g. to indicate the operating voltage and the operating state.

LED 1	LED 2	Function
continuously lit		Operating voltage switched on
flashing (1 Hz)		HF field switched off
flashing (2 Hz)		Tag within the detection range
	lit yellow (with read/write heads with automatic tuning)	less than 50 % range, too much metal in the environment

5.3.7 Available Device Types

Dimension drawing

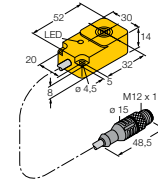
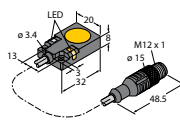
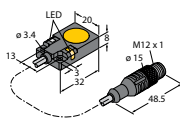

Type	TB-Q08-0.15-RS4.47T	TB-Q08-0.15-RS4.47T/C53	TN-Q14-0.15-RS4.47T
Ident no.	7030553	7030778	7030235
Operating frequency [MHz]	13.56	13.56	13.56
Material of active face	Plastic	Plastic	Plastic
Mounting conditions	flush	flush	non-flush
Housing material	metal	metal	Plastic
Housing length [mm]	32	32	56
Degree of protection	IP67	IP67	IP67
Ambient temperature [°C]	-25...+70	-25...+70	-25...+70
Special features	very flat design	very flat design, bus-capable	flat design
Approvals	-	-	-

Dimension drawing

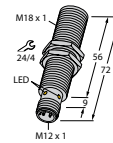
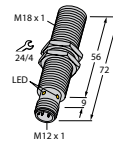
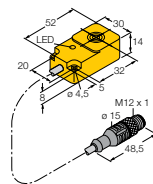

Type	TN-Q14-0.15-RS4.47T/C53	TB-M18-H1147	TB-EM18WD-H1147
Ident no.	7030779	7030001	7030224
Operating frequency [MHz]	13.56	13.56	13.56
Material of active face	Plastic	Plastic	Plastic
Mounting conditions	non-flush	flush	flush
Housing material	Plastic	metal	Stainless steel
Housing length [mm]	56	72	72
Degree of protection	IP67	IP67	IP68/IP69K
Ambient temperature [°C]	-25...+70	-25...+70	-25...+70
Special features	flat design, bus-capable	-	Wash-down (IP69K)

Dimension drawing

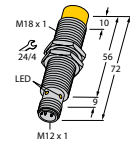
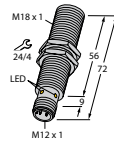
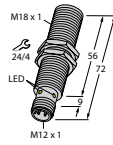

Type	TB-EM18WD-H1147-Ex	TB-M18-H1147/C53	TN-M18-H1147
Ident no.	7030381	7030729	7030002
Operating frequency [MHz]	13.56	13.56	13.56
Material of active face	Plastic	Plastic	Plastic
Mounting conditions	flush	flush	non-flush
Housing material	Stainless steel	metal	metal
Housing length [mm]	72	72	72
Degree of protection	IP68/IP69K	IP67	IP67
Ambient temperature [°C]	-25...+70	-25...+70	-25...+70
Special features	ATEX	bus-capable	–
Approvals	ATEX category II 3 G, Ex Zone 2 ATEX category II 3 D, Ex Zone 22	–	–

Dimension drawing

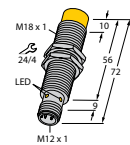
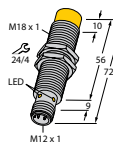

Type	TN-EM18WD-H1147	TN-EM18WD-H1147-Ex	TN-M18-H1147/C53
Ident no.	7030223	7030382	7030728
Operating frequency [MHz]	13.56	13.56	13.56
Material of active face	Plastic	Plastic	Plastic
Mounting conditions	non-flush	non-flush	non-flush
Housing material	Stainless steel	Stainless steel	metal
Housing length [mm]	72	72	72
Degree of protection	IP68/IP69K	IP68/IP69K	IP67
Ambient temperature [°C]	-25...+70	-25...+70	-25...+70
Special features	Wash-down (IP69K)	ATEX	bus-capable
Approvals	–	ATEX category II 3 G, Ex Zone 2 ATEX category II 3 D, Ex Zone 22	–

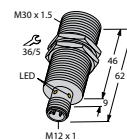
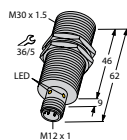
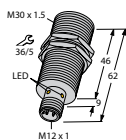
Dimension drawing

Type	TB-M30-H1147	TB-EM30WD-H1147	TB-EM30WD-H1147-Ex
Ident no.	7030003	7030221	7030385
Operating frequency [MHz]	13.56	13.56	13.56
Material of active face	Plastic	Plastic	Plastic
Mounting conditions	flush	flush	flush
Housing material	metal	Stainless steel	Stainless steel
Housing length [mm]	62	62	62
Degree of protection	IP67	IP68 / IP69K	IP68 / IP69K
Ambient temperature [°C]	-25...+70	-25...+70	-25 ...+70
Special features	–	Wash-down (IP69K)	ATEX
Approvals	–	–	ATEX category II 3 G, Ex Zone 2 ATEX category II 3 D, Ex Zone 22

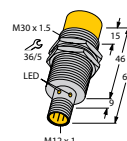
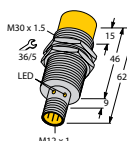
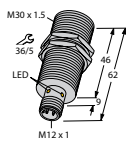
Dimension drawing

Type	TB-M30-H1147/C53	TN-M30-H1147	TN-EM30WD-H1147
Ident no.	7030731	7030004	7030222
Operating frequency [MHz]	13.56	13.56	13.56
Material of active face	Plastic	Plastic	Plastic
Mounting conditions	flush	non-flush	non-flush
Housing material	metal	metal	Stainless steel
Housing length [mm]	62	62	62
Degree of protection	IP67	IP67	IP68 / IP69K
Ambient temperature [°C]	-25...+70	-25...+70	-25...+70
Special features	bus-capable	–	Wash-down (IP69K)
Approvals	–	–	–

Dimension drawing

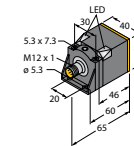
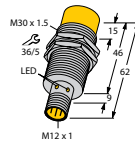
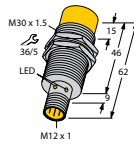

Type	TN-EM30WD-H1147-Ex	TN-M30-H1147/C53	TN-CK40-H1147
Ident no.	7030386	7030730	7030006
Operating frequency [MHz]	13.56	13.56	13.56
Material of active face	Plastic	Plastic	Plastic
Mounting conditions	non-flush	non-flush	non-flush
Housing material	Stainless steel	metal	Plastic
Housing length [mm]	62	62	65
Degree of protection	IP68 / IP69K	IP67	IP67
Ambient temperature [°C]	-25...+70	-25...+70	-25...+70
Special features	ATEX	bus-capable	–
Approvals	ATEX category II 3 G, Ex Zone 2 ATEX category II 3 D, Ex Zone 22	–	–

Dimension drawing

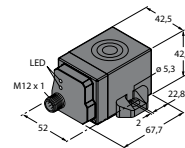
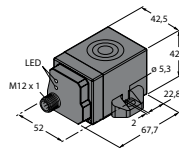
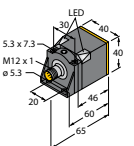

Type	TN-CK40-H1147/C53	TNSLR-Q42TWD-H1147	TNSLR-Q42TWD-H1147/C53
Ident no.	7030732	7030424	7030733
Operating frequency [MHz]	13.56	13.56	13.56
Material of active face	Plastic	Plastic	Plastic
Mounting conditions	non-flush	non-flush	non-flush
Housing material	Plastic	Plastic	Plastic
Housing length [mm]	65	68	68
Degree of protection	IP67	IP68 / IP69K	IP68 / IP69K
Ambient temperature [°C]	-25...+70	-25...+70	-25...+70
Special features	bus-capable	Wash-down (IP69K), very large range	Wash-down (IP69K), very large range, bus-capable

Dimension drawing

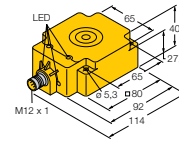
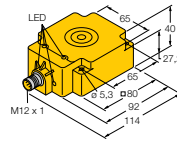
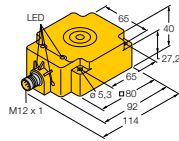

Type	TN-Q80-H1147	TN-Q80-H1147-EX	TNL-Q80-H1147
Ident no.	7030007	7030302	7030230
Operating frequency [MHz]	13.56	13.56	13.56
Material of active face	Plastic	Plastic	Plastic
Mounting conditions	non-flush	non-flush	non-flush
Housing material	Plastic	Plastic	Plastic
Housing length [mm]	92	92	92
Degree of protection	IP67	IP67	IP67
Ambient temperature [°C]	-25...+70	-25...+70	-25...+70
Special features	–	ATEX	–
Approvals	–	ATEX category II 3 G, Ex Zone 2 ATEX category II 3 D, Ex Zone 22	–

Dimension drawing

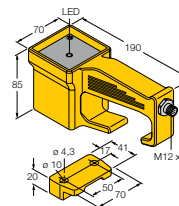
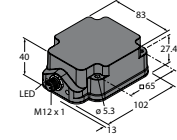
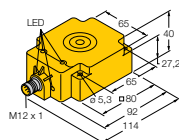

Type	TNL-Q80-H1147-EX	TNSLR-Q80WD-H1147	HT-IDENT-H1147
Ident no.	7030303	7030418	7030236
Operating frequency [MHz]	13.56	13.56	13.56
Material of active face	Plastic	Plastic	Plastic
Mounting conditions	non-flush	non-flush	non-flush
Housing material	Plastic	Plastic	–
Housing length [mm]	92	102	190
Degree of protection	IP67	IP68 / IP69K	IP67
Ambient temperature [°C]	-25...+70	-25...+70	-25...+70
Special features	ATEX	Wash-down (IP69K), very large range	Flexible use
Approvals	ATEX category II 3 G, Ex Zone 2 ATEX category II 3 D, Ex Zone 22	–	–

Dimension drawing

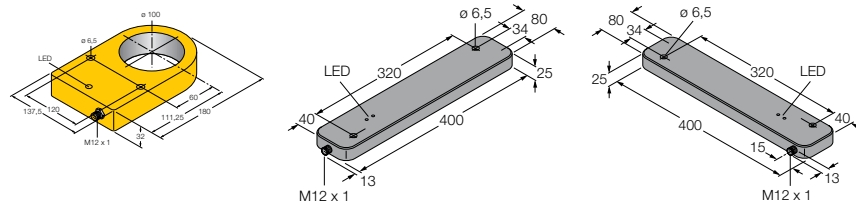

Type	TN-S32XL-H1147	TNLR-Q80L400-H1147	TNLR-Q80L400-H1147L
Ident no.	7030008	7030204	7030234
Operating frequency [MHz]	13.56	13.56	13.56
Material of active face	–	Plastic	Plastic
Mounting conditions	non-flush	non-flush	non-flush
Housing material	Plastic	Plastic	Plastic
Housing length [mm]	180	400	400
Degree of protection	IP67	IP67	IP67
Ambient temperature [°C]	-25...+70	-25...+70	-25...+70
Special features	–	suitable for roller conveyor applications (longitudinal or transverse alignment possible)	suitable for roller conveyor applications (longitudinal or transverse alignment possible), plug connector at side

Dimension drawing

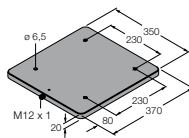

Type	TNSLR-Q350-H1147
Ident no.	7030454
Operating frequency [MHz]	13.56
Material of active face	Plastic
Mounting conditions	non-flush
Housing material	Plastic
Housing length [mm]	370
Degree of protection	IP67
Ambient temperature [°C]	-25...+70
Special features	very large range

5.3.8 Combination of HF Read/Write Heads and HF Tags

Notes on Operating Data

All operating data is stated in mm. The operating data is sufficient for a basic specification of the system. The relevant passing routes can be used for a more precise examination of the combination of read/write heads and tags. The passing routes can be obtained from Turck on request.

**NOTE**

For greater simplicity, basic parameters such as the effect of metal are not included in the operating data. Appropriate tests must be carried out before startup.

Operating Data – Tags and Read/Write Heads

Tag	R M L	Recommended distance max. distance Length of the transmission zone at the recommended distance										
		Read/write head	HT-IDENT-H1147 7030236	TB-EM18WD-H1147 7030224	TB-EM18WD-H1147-EX 7030381	TB-EM30WD-H1147 7030221	TB-EM30WD-H1147-EX 7030385	TB-M18-H1147 7030001	TB-M30-H1147 7030003	TB-Q08-0.15-RS4.47T 7030553	TN-CK40-H1147 7030006	TN-EM18WD-H1147 7030223
TW-BD10X1.5-19-B128 6901384	R	28	7		14.5		7	14.5	8	28	15.5	
	M	55	15		28		15	28	16.75	55	30	
	L	58	19		27		19	27	15.5	58	30	
TW-BS10X1.5-19-K2 6901380	R	8.5	5		7.5	7.5	5	7.5	5	8.5	6.5	6.5
	M	24	10.25		15	15	10.25	15	10	24	15	15
	L	30	13		17	17	13	17	11	30	18.5	18.5
TW-BS8X1.25-19-K2 7030638	R	7	5		6.5	6.5	5	6.5	5	7	6.5	6.5
	M	23	10.5		15.75	15.75	10.5	15.75	10.25	23	15.25	15.25
	L	31	13		21	21	13	21	12.5	31	19	19
TW-BS8X1.25-19-K9 7030647	R	9	5		6.5	6.5	5	6.5	5	9	6.5	6.5
	M	24	10.5		15.75	15.75	10.5	15.75	10.25	24	15.25	15.25
	L	30	13		21	21	13	21	12.5	30	19	19
TW-BV10X1.5-19-K2 6901382	R	8.5	5		7.5	7.5	5	7.5	5	8.5	6.5	6.5
	M	24	10.25		15	15	10.25	15	10	24	15	15
	L	30	13		17	17	13	17	11	30	18.5	18.5
TW-L18-18-F-B128 7030634	R	29	8.25		16	16	8.25	16	7	29	15	15
	M	56	16.75		29.5	29.5	16.75	29.5	13.75	56	30.25	30.25
	L	52	16		16	16	16	16	14	52	29	29
TW-L36-18-F-B128 7030659	R	32	6		13.5	13.5	6	13.5	6	32	13	13
	M	64	19.5		32	32	19.5	32	12.5	64	32	32
	L	70	33		41	41	33	41	25	70	42	42
TW-L40-P-B128 7030658	R	45	9.5		22	22	9.5	22	8	45	22	22
	M	87	25.5		42	42	25.5	42	16.50	87	45	45
	L	88	33		46	46	33	46	23	88	47	47
TW-L50-50-P-B128 7030635	R	52	10		23	23	10	23	5	52	20	20
	M	98	26		46	46	26	46		98	44	44
	L	100	40		54	54	40	54		100	56	56
TW-L81-49-P-B128 7030260	R	42	12		17		12	17		42	17	
	M	81	20		36		20	36		81	34	
	L	93	54		64		54	64		93	61	
TW-L81-49-P-B128 7030260	R	52	10		13	13	10	13	3	52	13	13
	M	104	23		32	32	23	32		104	37	37
	L	116	60		80	80	60	80		116	76	76
TW-L86-54-C-B128 6900479	R	40	7		14		7	14	3.5	40	8.5	
	M	88			32			32		88	32	
	L	94			40			40		94	65	
TW-Q51WH-HT-B128 7030661	R	52	10		20	20	10	20		52	25	25
	M	100	23		44	44	23	44	16.5	100	51	51
	L	104	31		52	52	31	52		104	70	70

Tag	R M L	Recommended distance max. distance Length of the transmission zone at the recommended distance										
		Read/write head	HT-IDENT-H1 147 7030236	TB-EM18WD-H1 147 7030224	TB-EM18WD-H1 147-EX 7030381	TB-EM30WD-H1 147 7030221	TB-EM30WD-H1 147-EX 7030385	TB-M18-H1 147 7030001	TB-M30-H1 147 7030003	TB-Q08-0.15-RS4.47T 7030553	TN-CK40-H1 147 7030006	TN-EM18WD-H1 147 7030223
TW-R10-M-B146 7030545	R M L	7 18 30	5 7 7		6 15 18		5 7 7	6 15 18	5 7 7	7 18 30	5 12 14	
TW-R12-M-B146 7030500	R M L	7 18 30	5 7 7		6 15 18		5 7 7	6 15 18	5 7 7	7 18 30	5 12 14	
TW-R16-B128 6900501	R M L	25 50.5 53	7.5 16.75 20		14 28.5 27		7.5 16.75 20	14 28.5 27	8 16.75 18	25 50.5 53	14.75 30.5 33	
TW-R16-K2 7030410	R M L	17 37 42	3.5 11 14.5		8 19 21		3.5 11 14.5	8 19 21	4 10.75 14	17 37 42	8.25 19.25 23	
TW-R20-B128 6900502	R M L	28 55 54	9.75 19.5 18.5		15 29.5 29		9.75 19.5 18.5	15 29.5 29	8 16.5 18	28 55 54	15 29.5 28	
TW-R20-B128-EX 7030242	R M L				9.75 19.5 18.5		15 29.5 29					15 29.5 28
TW-R20-K2 6900505	R M L	20 41 46	7.5 16.5 17.5		12.5 26 27		7.5 16.5 17.5	12.5 26 27	6 14.75 15.5	20 41 46	13.25 27 30	
TW-R20-K2-EX 7030245	R M L				7.5 16.5 17.5		12.5 26 27		6 14.75 15.5			13.25 27 30
TW-R30-B128 6900503	R M L	38 72 72	10 21 25		17 35.5 36		10 21 25	17 35.5 36	8 18.5 25.5	38 72 72	18.75 37.5 44	
TW-R30-B128-EX 7030243	R M L				10 21 25		17 35.5 36		8 18.5 25.5			18.75 37.5 44
TW-R30-K2 6900506	R M L	30 59 62	6 13.75 20		10.5 25.5 33		6 13.75 20	10.5 25.5 33	11.5 59 62	30 59 62	11 26 34	
TW-R30-K2-EX 7030246	R M L				6 13.75 20		10.5 25.5 33					11 26 34
TW-R30-K9 7030565	R M L	31 62 64	6.5 17.25 22		14.5 30.5 34		6.5 17.25 22	14.5 30.5 34	13.5 62 64	31 62 64	15 32 38	
TW-R30-M-B128 7030210	R M L	8.5 22 27	9.5				9.5			8.5 22 27	5.5 14 20	

Tag	R Recommended distance M max. distance L Length of the transmission zone at the recommended distance	Read/write head	HT-IDENT-H1 147 7030236	TB-EM18WD-H1 147 7030224	TB-EM18WD-H1 147-EX 7030381	TB-EM30WD-H1 147 7030221	TB-EM30WD-H1 147-EX 7030385	TB-M18-H1 147 7030001	TB-M30-H1 147 7030003	TB-Q08-0.15-RS4.47T 7030553	TN-CK40-H1 147 7030006	TN-EM18WD-H1 147 7030223	TN-EM18WD-H1 147-EX 7030382
TW-R30-M-K2 7030206	R	12	7					7			12	7	
	M	27.5	10					10			27.5	17	
	L	31	18					18			31	22.5	
TW-R4-22-B128 7030237	R	19	3.25		8.5		3.25	8.5	2.5	19	8		
	M	44.5	11.5		21.5		11.5	21.5	9.5	44.5	21		
	L	51	16.5		26		16.5	26	15.5	51	27		
TW-R50-B128 6900504	R	47	19.5		17		19.5	17	11.5	47	20		
	M	92			41			41		92	45		
	L	94			48			48		94	58		
TW-R50-B128-EX 7030244	R			19.5		17							20
	M					41							45
	L					48							58
TW-R50-K2 6900507	R	43	17.5		13		17.5	13	8	43	17		
	M	84			37			37		84	40.5		
	L	88			48			48		88	52		
TW-R50-K2-EX 7030247	R			17.5		13							17
	M					37							40.5
	L					48							52
TW-R50-M-B128 7030209	R	21	8		15		8	15		21	10		
	M	43	18		27		18	27		43	22		
	L	46	22		22		22	22		46	22		
TW-R50-M-K2 7030229	R	11	7		10		7	10		11	10		
	M	30	15		21		15	21		30	22		
	L	36	24		26		24	26		36	32		
TW-R7.5-B128 7030231	R	13	6.25		9		6.25	9	6.25	13	10		
	M	29.5	13		20		13	20	12.5	29.5	20.5		
	L	34	14.5		20		14.5	20	13.5	34	23.5		
TW-R80-M-B128 7030207	R	22								22			
	M	47.5								47.5			
	L	50								50			
TW-R80-M-K2 7030205	R	18								18			
	M	43								43			
	L	50								50			
TW-R9.5-B128 7030252	R	18	5.5		10		5.5	10	5.5	18	10		
	M	37.5	13		20.5		13	20.5	11.75	37.5	20.5		
	L	42	14		21		14	21	13	42	22		
TW-R9.5-K2 7030558	R	18	5.5		9		5.5	9	5.5	18	9.75		
	M	38.5	13		20.5		13	20.5	12	38.5	20.5		
	L	42	12.5		22		12.5	22	13.5	42	23.5		

Tag	R Recommended distance M max. distance L Length of the transmission zone at the recommended distance	Read/write head										
		TN-EM30WD-H1 147 7030222	TN-EM30WD-H1 147-EX 7030386	TNLR-Q80-H1 147 7030230	TNLR-Q80-H1 147-EX 7030303	TNLR-Q80L400-H1 147 longitudinal 7030204	TNLR-Q80L400-H1 147 traverse 7030204	TNLR-Q80L400-H1 147L longitudinal 7030234	TNLR-Q80L400-H1 147L traverse 7030234	TNLR-Q80L800-H1 147 longitudinal 7030522	TNLR-Q80L800-H1 147 traverse 7030522	TN-M18-H1 147 7030002
TW-BD10X1.5-19-B128 6901384	R	21		52		42		42		35		15.5
	M	40.5		97		136		136		130		30
	L	44		100		408		408		810		30
TW-BS10X1.5-19-K2 6901380	R	8.5	8.5	18		16		16		5		6.5
	M	20.5	20.5	41						20		15
	L	23	23	56						780		18.5
TW-BS8X1.25-19-K2 7030638	R	8.5	8.5	18						5		6.5
	M	21	21	44						20		15.25
	L	28	28	54						770		19
TW-BS8X1.25-19-K9 7030647	R	8.5	8.5	18						5		6.5
	M	21	21	44						20		15.25
	L	28	28	54						770		19
TW-BV10X1.5-19-K2 6901382	R	8.5	8.5	18		16		16		5		6.5
	M	20.5	20.5	41						20		15
	L	23	23	56						780		18.5
TW-L18-18-F-B128 7030634	R	22	22	47		40	60	40	60	42	60	15
	M	41.5	41.5	90		130	128	130	128	155	128	30.25
	L	41	41	86		416	116	416	116	820	116	29
TW-L36-18-F-B128 7030659	R	22	22	58		46	81	46	81		81	13
	M	47	47	112		152	152	152	152		152	32
	L	54	54	112		432	156	432	156		156	42
TW-L40-P-B128 7030658	R	36	36	84		93	145	93	145	100	145	22
	M	65	65	152		250	255	250	255	305	255	45
	L	74	74	148		460	230	460	230	860	230	47
TW-L50-50-P-B128 7030635	R	35	35	94		100	145	100	145	105	145	20
	M	68	68	170		250	255	250	255	325	255	44
	L	72	72	164		470	250	470	250	860	250	56
TW-L81-49-P-B128 7030260	R	25		76		270	270	270	270		270	17
	M	55		142		100	150	100	150		150	34
	L	71		144		488	238	488	238		238	61
TW-L81-49-P-B128 7030260	R	27	27	94		100	145	100	145	110	145	13
	M	66	66	180		265	270	265	270	355	270	37
	L	92	92	184		480	240	480	240	900	240	76
TW-L86-54-C-B128 6900479	R	25		89		75	200	75	200	75	200	8.5
	M	62		170		240	345	240	345	280	345	32
	L	96		164		480	306	480	306	860	306	65
TW-Q51WH-HT-B128 7030661	R	39	39	105		127		127		115		25
	M	76	76	190		315		315		360		51
	L	78	78	188		500		500		890		70
TW-R10-M-B146 7030545	R	7		15								5
	M	17		36								12
	L	30		68								14

R M L	Recommended distance max. distance Length of the transmission zone at the recommended distance											
Tag	Read/write head	TN-EM30WD-H1 147 7030222	TN-EM30WD-H1 147-EX 7030386	TNLR-Q80-H1 147 7030230	TNLR-Q80-H1 147-EX 7030303	TNLR-Q80L400-H1 147 longitudinal 7030204	TNLR-Q80L400-H1 147 traverse 7030204	TNLR-Q80L400-H1 147L longitudinal 7030234	TNLR-Q80L400-H1 147L traverse 7030234	TNLR-Q80L800-H1 147 longitudinal 7030522	TNLR-Q80L800-H1 147 traverse 7030522	TN-M18-H1 147 7030002
TW-R12-M-B146 7030500	R M L	7 17 30		15 36 68								5 12 14
TW-R16-B128 6900501	R M L	21 42 43		51 100 104		48 148 420	50 95 74	48 148 420	50 95 74	40 145 810	50 95 74	14.75 30.5 33
TW-R16-K2 7030410	R M L	13 28.5 32		34 71 76		16 76 392		16 76 392		20 80 800		8.25 19.25 23
TW-R20-B128 6900502	R M L	21.5 42.5 43		54 99 106		48 140 416	60 102 86	48 140 416	60 102 86	35 135 810	60 102 86	15 29.5 28
TW-R20-B128-EX 7030242	R M L		21.5 42.5 43	54 99 106								
TW-R20-K2 6900505	R M L	19 40 42		51 96 98		36 124 408	15 64 70	36 124 408	15 64 70	40 135 810	15 64 70	13.25 27 30
TW-R20-K2-EX 7030245	R M L		19 40 42	51 96 98								
TW-R30-B128 6900503	R M L	28.5 56 59		76 140 136		88 232 448	90 152 132	88 232 448	90 152 132	70 240 850	90 152 132	18.75 37.5 44
TW-R30-B128-EX 7030243	R M L		28.5 56 59	76 140 136								
TW-R30-K2 6900506	R M L	19.5 41 50		54 102 104		40 136 416	70 122 100	40 136 416	70 122 100	40 155 820	70 122 100	11 26 34
TW-R30-K2-EX 7030246	R M L		19.5 41 50	54 102 104								
TW-R30-K9 7030565	R M L	24 48.5 53		65 120 124		50 152 424		50 152 424		50 185 830		15 32 38
TW-R30-M-B128 7030210	R M L							10		0		5.5 14 20
TW-R30-M-K2 7030206	R M L							10		5 15 770		7 17 22.5

Tag	R M L	Recommended distance max. distance Length of the transmission zone at the recommended distance											
		Read/write head	TN-EM30WD-H1 147 7030222	TN-EM30WD-H1 147-EX 7030386	TNLR-Q80-H1 147 7030230	TNLR-Q80-H1 147-EX 7030303	TNLR-Q80L400-H1 147 longitudinal 7030204	TNLR-Q80L400-H1 147 traverse 7030204	TNLR-Q80L400-H1 147L longitudinal 7030234	TNLR-Q80L400-H1 147L traverse 7030234	TNLR-Q80L800-H1 147 longitudinal 7030522	TNLR-Q80L800-H1 147 traverse 7030522	TN-M18-H1 147 7030002
TW-R4-22-B128 7030237	R	13			40		32	40	32	40	22	40	8
	M	33.5			86		116	78	116	78	114	78	21
	L	42			98		408	68	408	68	812	68	27
TW-R50-B128 6900504	R	35			98		108	150	108	150	105	150	20
	M	70			178		280	256	280	256	345	256	45
	L	72			176		484	230	484	230	880	230	58
TW-R50-B128-EX 7030244	R		35		98								
	M		70		178								
	L		72		176								
TW-R50-K2 6900507	R	30			88		92	120	92	120	95	120	17
	M	63			162		248	216	248	216	300	216	40.5
	L	68			160		468	190	468	190	870	190	52
TW-R50-K2-EX 7030247	R		30		88								
	M		63		162								
	L		68		160								
TW-R50-M-B128 7030209	R	20			35				10		5		10
	M	36			58				30		40		22
	L	34			64				380		780		22
TW-R50-M-K2 7030229	R	15			30				10		5		10
	M	30			58				20		20		22
	L	32			76				370		760		32
TW-R7.5-B128 7030231	R	13.5			30		18		18		12		10
	M	28			64		50		50		64		20.5
	L	28			70		376		376		804		23.5
TW-R80-M-B128 7030207	R				50		30	40	25	40	20	40	
	M				90		77	77	70	77	75	77	
	L				90		398	56	390	56	780	56	
TW-R80-M-K2 7030205	R				35		30	30	25	30	15	30	
	M				78		68	77	70	77	60	77	
	L				80		390	64	380	64	780	64	
TW-R9.5-B128 7030252	R	14.5			36		36		36		25		10
	M	30.5			74		76		76		80		20.5
	L	30			82		384		384		800		22
TW-R9.5-K2 7030558	R	14			34		26		26		20		9.75
	M	29			71		72		72		75		20.5
	L	29			76		384		384		800		23.5

Tag	R M L	Recommended distance max. distance Length of the transmission zone at the recommended distance							
		Read/write head	TN-M30-H1147 7030004	TN-Q14-0.15-RS4.47T 7030235	TN-Q80-H1147 7030007	TN-Q80-H1147-EX 7030302	TN-S32XL-H1147 7030008	TNSLR-Q350-H1147 7030545	TNSLR-Q42TWD-H1147 7030424
TW-BD10X1.5-19-B128 6901384	R	21	20	36			100	53	73
	M	40.5	39	73			250	96	137
	L	44	41	78			390	100	132
TW-BS10X1.5-19-K2 6901380	R	8.5	6.5	10				20	26
	M	20.5	18	23.5				42	52
	L	23	25	41				44	68
TW-BS8X1.25-19-K2 7030638	R	8.5	7					23	22
	M	21	19					45	56
	L	28	25					46	72
TW-BS8X1.25-19-K9 7030647	R	8.5	7					23	22
	M	21	19					45	56
	L	28	25					46	72
TW-BV10X1.5-19-K2 6901382	R	8.5	6.5	10				20	26
	M	20.5	18	23.5				42	52
	L	23	25	41				44	68
TW-L18-18-F-B128 7030634	R	22	19.5	35			122	55	73
	M	41.5	38.5	71			284	103	136
	L	41	40	78			408	100	132
TW-L36-18-F-B128 7030659	R	22	20	41				69	80
	M	47	44	85				128	150
	L	54	52	94				124	144
TW-L40-P-B128 7030658	R	36	31	68			260	97	122
	M	65	60	128			505	174	216
	L	74	56	124			560	168	196
TW-L50-50-P-B128 7030635	R	35	35	75			280	110	125
	M	68	70	142			540	200	225
	L	72	76	132			590	190	210
TW-L81-49-P-B128 7030260	R	25	25	55		68			
	M	55	55	108		136			
	L	71	71	115		161			
TW-L81-49-P-B128 7030260	R	27	28	68			290		125
	M	66	70	138			565		230
	L	92	94	148			620		220
TW-L86-54-C-B128 6900479	R	25	21	57		90	230	90	117
	M	62	58	120		180	470	166	216
	L	96	96	124		206	540	180	230
TW-Q51WH-HT-B128 7030661	R	39	34	71			300	108	147
	M	76	68	134			600	194	261
	L	78	74	136			640	192	252
TW-R10-M-B146 7030545	R	7	5	10				20	25
	M	17	14	24				42	52
	L	30	24	52				75	80

Tag	R M L	Recommended distance max. distance Length of the transmission zone at the recommended distance								
		Read/write head	TN-M30-H1147 7030004	TN-Q14-0.15-RS4.47T 7030235	TN-Q80-H1147 7030007	TN-Q80-H1147-EX 7030302	TN-S32XL-H1147 7030008	TNSLR-Q350-H1147 7030545	TNSLR-Q42TWD-H1147 7030424	TNSLR-Q80WD-H1147 7030418
TW-R12-M-B146 7030500	R	7	5	10				20	25	
	M	17	14	24				42	52	
	L	30	24	52				75	80	
TW-R16-B128 6900501	R	21	17.5	40		20	105	60	76	
	M	42	39.5	82		67	250	110	146	
	L	43	42	84		125	380	112	158	
TW-R16-K2 7030410	R	13	11.5	16			35	36	50	
	M	28.5	26	45			135	71	97	
	L	32	33	60			330	78	106	
TW-R20-B128 6900502	R	21.5	18.5	41		36	95	60	76	
	M	42.5	37.5	82		72	235	114	140	
	L	43	40	92		103	380	110	140	
TW-R20-B128-EX 7030242	R		18.5		41			60	76	
	M		37.5		82			114	140	
	L		40		92			110	140	
TW-R20-K2 6900505	R	19	18	30		20	50	53	70	
	M	40	37	65.5		60	170	98	130	
	L	42	41	72		130	340	102	132	
TW-R20-K2-EX 7030245	R		18		30			53	70	
	M		37		65.5			98	130	
	L		41		72			102	132	
TW-R30-B128 6900503	R	28.5	25	48		30	185	76	110	
	M	56	50.5	96		80	385	142	186	
	L	59	52	96		120	470	144	176	
TW-R30-B128-EX 7030243	R		25		48			76	110	
	M		50.5		96			142	186	
	L		52		96			144	176	
TW-R30-K2 6900506	R	19.5	16.5	31		30	105	54	74	
	M	41	36.5	69		82	255	104	138	
	L	50	42	78		132	390	104	136	
TW-R30-K2-EX 7030246	R				31					
	M				69					
	L				78					
TW-R30-K9 7030565	R	24	21	41			150	66	90	
	M	48.5	44	83			325	120	164	
	L	53	50	92			430	120	152	
TW-R30-M-B128 7030210	R						0	16	20	
	M							34	40	
	L							30	56	
TW-R30-M-K2 7030206	R						0	23	30	
	M							34	58	
	L							40	64	

Tag	R M L	Recommended distance max. distance Length of the transmission zone at the recommended distance								
		Read/write head	TN-M30-H1147 7030004	TN-Q14-0.15-RS4.47T 7030235	TN-Q80-H1147 7030007	TN-Q80-H1147-EX 7030302	TN-S32XL-H1147 7030008	TNSLR-Q350-H1147 7030545	TNSLR-Q42TWD-H1147 7030424	TNSLR-Q80WD-H1147 7030418
TW-R4-22-B128 7030237	R	13	10.5	32		10	80	51	63	
	M	33.5	28.5	72		42	225	101	128	
	L	42	40	84		118	380	104	130	
TW-R50-B128 6900504	R	35	30	63		80	280	100	134	
	M	70	63	122		150	540	182	240	
	L	72	70	124		160	610	180	228	
TW-R50-B128-EX 7030244	R				63					
	M				122					
	L				124					
TW-R50-K2 6900507	R	30	26	57		60	235	88	120	
	M	63	56	110		28	460	162	218	
	L	68	70	112		160	540	164	208	
TW-R50-K2-EX 7030247	R				57					
	M				110					
	L				112					
TW-R50-M-B128 7030209	R	20	20	25			5	41	36	
	M	36	36	53				72	75	
	L	34	34	66				64	80	
TW-R50-M-K2 7030229	R	15	15	15			0	27	30	
	M	30	30	41				50	67	
	L	32	32	58				50	78	
TW-R7.5-B128 7030231	R	13.5	11	20			35	36	48	
	M	28	26	50			125	71	96	
	L	28	30.5	62			330	74	104	
TW-R80-M-B128 7030207	R			40			5	46	62	
	M			76				84	114	
	L			76				76	108	
TW-R80-M-K2 7030205	R			20			5	42	51	
	M			55				79	99	
	L			64				74	94	
TW-R9.5-B128 7030252	R	14.5	12	19			40	38	50	
	M	30.5	27	47			145	74	100	
	L	30	32	60			330	76	106	
TW-R9.5-K2 7030558	R	14	11.5	17			35	36	48	
	M	29	26	46			130	71	97	
	L	29	31.5	62			350	74	106	

5.3.9 Accessories – HF Read/Write Heads

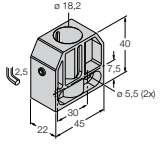
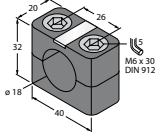
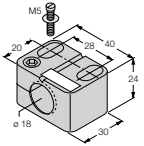
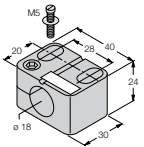
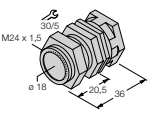
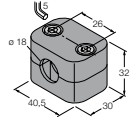
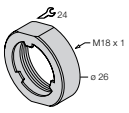
Dimension drawing	Type	Ident no.	Description
	BS 18	69471	Fixing clamp for threaded barrel devices; Material: PA66-GF
	BSN 18	69472	Fixing clamp; Material: PA66-GF
	BST-18B	6947214	Fixing clamp for threaded barrel devices; with dead stop; Material: PA6
	BST-18N	6947215	Fixing clamp for threaded barrel devices; without dead stop; Material: PA6
	QM-18	6945102	Quick-mount bracket with dead stop; Material: Chrome-plated brass. Male thread M24 x 1.5. Note: The switching distance of the proximity switches can be reduced by using quick-mount brackets.
	BSS-18	6901320	Fixing clamp for smooth and threaded barrel devices; Material: Polypropylene
	PN-M18	6905310	Protective nut for M18x1 threaded barrel devices; Material: Stainless steel A2 1.4305 (AISI 303)

	MW-18	6945004	Mounting bracket for threaded barrel devices; Material: Stainless steel A2 1.4301 (AISI 304)
	SKN/M18	69663	PTFE protective caps; Material PTFE; For use in welding plants and cutting machines with flying sparks
	BST-30B	6947216	Fixing clamp for threaded barrel devices; with dead stop; Material: PA6
	BST-30N	6947217	Mounting bracket for threaded barrel devices; without dead stop; Material: PA6
	QM-30	6945103	Quick-mount bracket with dead stop; Material: Chrome-plated brass. Male thread M36 x 1.5. Note: The switching distance of the proximity switches can be reduced by using quick-mount brackets.
	BSS-30	6901319	Fixing clamp for smooth and threaded barrel devices; Material: Polypropylene
	PN-M30	6905308	Protective nut for M30x1 threaded barrel devices; Material: Stainless steel A2 1.4305 (AISI 303)
	MW-30	6945005	Mounting bracket for threaded barrel devices; Material: Stainless steel A2 1.4301 (AISI 304)

	SKN/M30	69664	PTFE protective caps; Material PTFE; For use in welding plants and cutting machines with flying sparks
	BSS-SPV2	6901316	Welding plate for BSS fixing clamp, long
	BSS-TSM (2 pcs.)	6901323	DIN rail nut for BSS fixing clamp, for standard rail mounting
	BST-UV	6947218	Base for BST-12 and BST-18 fixing clamps
	MW-Q14/Q20	6945006	Mounting bracket for rectangular Q14 or Q20; Material VA 1.4301
	BSS-CP40	6901318	Fixing clamp for rectangular devices; Material: Polypropylene
	MF-CK40-3S	6900483	Protective frame (U profile) for rectangular CK40
	MF-CK40-2S	6900482	Protective frame (bracket) for rectangular CK40

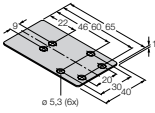
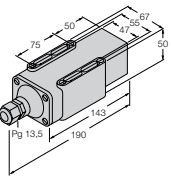
	<p>MF-CK40-1S</p>	<p>6900481</p>	<p>Protective frame (one-sided) for rectangular CK40</p>
	<p>PROTECTIVE HOUSING SG40/2 (ULTEM)</p>	<p>69497</p>	<p>Protective housing for rectangular CP40; Material housing/cover: ULTEM; Temp. resistant up to +170 °C, particularly UV and ozone resistant; Degree of protection IP68, 5 m ws</p>

5.4 HF Tags

5.4.1 Type Code

W ... - **Q51** - **M** - **HT** - **B128** - **Ex**

W ... **Data carrier** - **Q51** **Housing** - **M** **Features**

<p>Working frequency</p> <ul style="list-style-type: none"> blank 13.56 MHz 865-868 865...868 MHz 865-928 865...928 MHz 860-960 860...960 MHz 902-928 902...928 MHz <p>Data carrier, memory access</p> <ul style="list-style-type: none"> W read/write R read only <p>Turck RFID-System BL ident®</p>	<p>Housing</p> <ul style="list-style-type: none"> BD10X1.5-19 screw housing, plastic, M10 x 1.5, wrench size 19 mm BS10X1.5-19 screw housing, metal/plastic, M10 x 1.5, wrench size 19 mm BV10X1.5-19 screw housing, stainless steel/plastic, M10 x 1.5, wrench size 19 mm I... inlay & dimensions L... label & dimensions Q...L... rectangular & diameter Q51 rectangular & lateral length: 51 mm R... round & diameter 	<p>Features</p> <ul style="list-style-type: none"> C cheque card format F foil data carrier M for direct mounting on metal MF for direct mounting on metal, foil shielded P paper data carrier
--	---	---

High temperature (optional) - **B128** **Memory capacity total** - **Ex** **Approvals**

<p>High temperature</p> <ul style="list-style-type: none"> HT High temperature 	<p>Memory capacity total (size)</p> <ul style="list-style-type: none"> B... ... Byte K... ... kByte 	<p>Approvals</p> <ul style="list-style-type: none"> Ex Approval for Ex-Area
---	--	--

5.4.2 Features of the HF Tags

- EEPROM tags with 128 byte memory, FRAM tags with 2 Kbytes or 8 Kbytes for high speeds
- High temperature tags for use at -40...+240 °C, depending on ambient conditions, time and cycle dependent
- Autoclave tags for use in pressurized hot water vapor
- Open and globally applicable standards (ISO 15693)
- Tags for Ex applications
- Round, flat tags with 16, 20, 30 and 50 mm diameters
- Inlays and stickers in foil thickness
- Designs for installation in and on metal
- Tags in glass cylindrical housing
- Tags in check card format
- Tags with fixing holes

Memory

Tags are available with EEPROM and FRAM memory. The memory size is 128 bytes (user data area 112 bytes), 2 Kbytes (user data area 2000 bytes) or 9 Kbytes (user data area 7936 bytes).

- FRAM tags (ferroelectric random access memory, non-volatile) with a 2 or 8 Kbyte memory size can guarantee 10^{10} read / write operations.
- EEPROM tags (electrically erasable programmable read only memory, non-volatile) can ensure an unlimited number of read operations and 10^4 or 10^5 write operations.

The following approximate values apply to the data retention time of the memories. The values may vary according to the type of chip.

- 1 year at 85 °C
- 10 years at 55 °C
- 120 years at 25 °C

Electrical fields have no effect on the data retention time as they are normally too low frequency to delete the memory.

5.4.3 Setup of the HF Tags

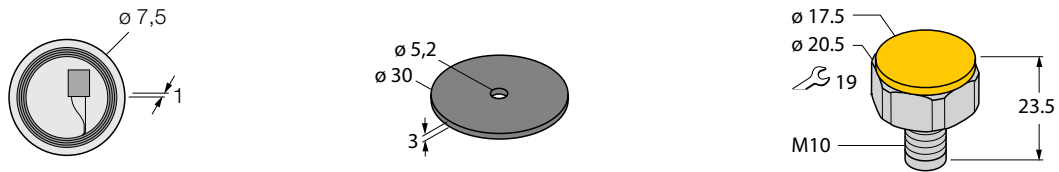

Fig. 17: HF tags (examples)

Tags for a wide range of applications are available. Other properties of the tags include:

- Types for direct mounting on metal
- Types for particularly large temperature ranges, also high temperatures (-40... +240 °C)
- Type for use in autoclaves (pressurized water vapor)
- Types as (printable) label (adhesive or inlay) in foil thickness

5.4.4 Operating Principle

An RFID tag is a mobile data memory consisting of a memory chip and a coupling element (coil or antenna). It can be written or read without contact in an RFID system. Tags with EEPROM and FRAM memories are available. Tags provide information on the object to which they are fitted, e.g. a unique identification number, batch number or specific production data. Prior to use, the tag is written with a worldwide uniquely assigned number, e.g. for UHF tags compliant with the EPCglobal Class 1 Gen 2 standard (ISO18000-6C) and for HF tags according to ISO 15693.

BL ident® tags are passive, i.e. they operate without the use of a battery and are powered by the magnetic or electromagnetic field generated by the read/write head. If the tag enters the transmission field of the read/write head, it is activated for writing and reading the data. To do this, the tag does not generate its own field but simply changes the field of the read/write head by modulating the load. For this a load resistor is switched on and off in time with the data to be transmitted, thus changing the mutual inductance of the HF tag or the properties of the wave reflected by the UHF tag. These changes are detected and evaluated by the read/write head.

The Turck tags can be written to and read from without contact by a number of Turck read/write heads. This requires the read/write heads and the tags to operate in the same frequency range. The detection ranges of the devices – depending on power and frequency – vary from a few millimeters to several meters. The specified maximum read/write distances only represent typical values under laboratory conditions without allowing for the effect of materials. The achievable distances may be different due to component tolerances, mounting location in the application, ambient conditions and the effect of materials (particularly metal and liquids).

5.4.5 User Data Areas of Tags

The tags are provided with different chip types. The user data areas of the tags are described in the following table.

Chip type	User data area		Total memory [Byte]	Access	Bytes per block
	First block	Last block			
NXP SL2 SLI	0x00	0x1B	112	read/write	4
NXP SL2 SLI-S	0x00	0x27	160	read/write	4
NXP SL2 SLI-L	0x00	0x07	32	read/write	4
Fujitsu MB89R118 Fujitsu MB89R118B	0x00	0xF9	2000	read/write	8
Fujitsu MB89R112	0x00	0xFF	8192	read/write	32
TI Tag-it HFI Plus	0x00	0x3F	256	read/write	4
TI Tag-it HFI	0x00	0x07	32	read/write	4
infineon SRF55V02P	0x00	0x37	224	read/write	4
infineon SRF55V10P	0x00	0xF7	992	read/write	4
EM4233	0x00	0x33	208	read/write	4
EM4233 SLIC	0x00	0x1F	128	read/write	4

5.4.6 Available Device Types

Turck can also supply customized tag solutions on request.

Dimension drawing

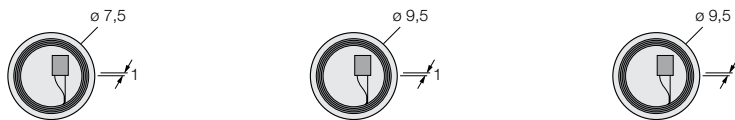

Type	TW-R7.5-B128	TW-R9.5-B128	TW-R9.5-K2
Ident no.	7030231	7030252	7030558
Operating frequency [MHz]	13.56	13.56	13.56
Material of active face	Plastic	Plastic	Plastic
Housing material	Plastic	Plastic	Plastic
Memory size [Byte]	128	128	2048
Memory type	EEPROM	EEPROM	FRAM
Chip type	NXP I-Code SLI/SL2	NXP I-Code SLI/SL2	Fujitsu MB89R118
Number of read operations	unlimited	unlimited	unlimited
Number of write operations	10 ⁵	10 ⁵	10 ¹⁰
Typical read time [ms/byte]	2	2	0.5
Typical write time [ms/byte]	3	3	0.5
Degree of protection	IP67	IP68	IP68
Ambient temperature [°C]	-25 ...+85	-25 ...+85	-25...+85
Storage temperature range	-	-	-
Storage temperature [°C]	-40...+85	-40...+85	-40 ...+85
Special features	Small design	Small design	Small design

Dimension drawing

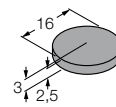
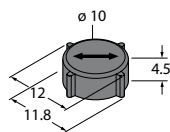
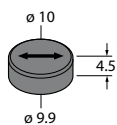

Type	TW-R10-M-B146	TW-R12-M-B146	TW-R16-B128
Ident no.	7030545	7030500	6900501
Operating frequency [MHz]	13.56	13.56	13.56
Material of active face	Plastic	Plastic	Plastic
Housing material	Plastic	Plastic	Plastic
Memory size [Byte]	146	146	128
Memory type	EEPROM	EEPROM	EEPROM
Chip type	EM4233SLIC	EM4233SLIC	NXP I-Code SLI/SL2
Number of read operations	unlimited	unlimited	unlimited
Number of write operations	10 ⁵	10 ⁵	10 ⁵
Typical read time [ms/byte]	2	2	2
Typical write time [ms/byte]	3	3	3
Degree of protection	IP68	IP68	IP69K
Ambient temperature [°C]	-40 ...+85	-40 ...+85	-25 ...+85
Storage temperature range	-	-	160 °C (1x35 h) 220 °C (1x30 s)
Storage temperature [°C]	-40...+85	-40...+85	-25...+120
Special features	Tag is designed for direct mounting on/in metal. A recommendation for adhesives that meet the FD and EU requirements for accidental contact with food can be requested from Turck. This recommendation does release the user from an examination regarding suitability for the application.	Tag is designed for direct mounting on/in metal. A recommendation for adhesives that meet the FDA and EU requirements for accidental contact with food can be requested from Turck. This recommendation does release the user from an examination regarding suitability for the application.	Extended temperature range

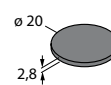
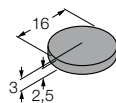
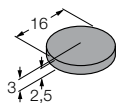
Dimension drawing

Type	TW-R16-B128-Ex	TW-R16-K2	TW-R20-B128
Ident no.	7030241	7030410	6900502
Operating frequency [MHz]	13.56	13.56	13.56
Material of active face	Plastic, PA6, black	Plastic	Plastic
Housing material	Plastic, PPS	Plastic	Plastic
Memory size [Byte]	128	2048	128
Memory type	EEPROM	FRAM	EEPROM
Chip type	NXP I-Code SLI/SL2	Fujitsu MB89R118	NXP I-Code SLI/SL2
Number of read operations	unlimited	unlimited	unlimited
Number of write operations	10 ⁵	10 ¹⁰	10 ⁵
Typical read time [ms/byte]	2	0.5	2
Typical write time [ms/byte]	3	0.5	3
Degree of protection	IP69K	IP69K	IP69K
Ambient temperature [°C]	-25... +85 °C	-25 ...+85	-25 ...+85
Storage temperature range	160 °C, 1x35 h	160 °C (1x35 h) 220 °C (1x30 s)	140 °C (1x100 h)
Storage temperature [°C]	220 °C, 1x30 s	-25...+120	-45...+85
Special features	-25...+120 °C	Extended temperature range	-
Approvals	extended temperature range, ATEX	ATEX category II 2 G, Ex Zone 1 ATEX category II 2 D, Ex Zone 21	-

Dimension drawing

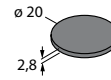
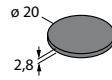
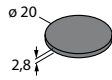

Type	TW-R20-B128-Ex	TW-R20-K2	TW-R20-K2-Ex
Ident no.	7030242	6900505	7030245
Operating frequency [MHz]	13.56	13.56	13.56
Material of active face	Plastic	Plastic	Plastic
Housing material	Plastic	Plastic	Plastic
Memory size [Byte]	128	2048	2048
Memory type	EEPROM	FRAM	FRAM
Chip type	NXP I-Code SLI/SL2	Fujitsu MB89R118	Fujitsu MB89R118
Number of read operations	unlimited	unlimited	unlimited
Number of write operations	10 ⁵	10 ¹⁰	10 ¹⁰
Typical read time [ms/byte]	2	0.5	0.5
Typical write time [ms/byte]	3	0.5	0.5
Degree of protection	IP69K	IP69K	IP69K
Ambient temperature [°C]	-25 ...+85	-25 ...+85	-25 ...+85
Storage temperature range	140 °C (1 × 100 h)	140 °C (1 × 100 h)	140 °C (1 × 100 h)
Storage temperature [°C]	-45...+85	-45...+85	-45...+85
Special features	ATEX	-	ATEX
Approvals		-	ATEX category II 2 G, Ex Zone 1 ATEX category II 2 D, Ex Zone 21

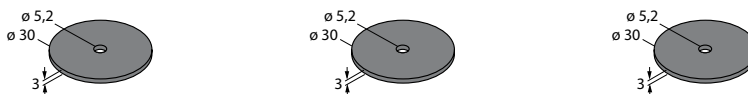
Dimension drawing

Type	TW-R30-B128	TW-R30-B128-Ex	TW-R30-K2
Ident no.	6900503	7030243	6900506
Operating frequency [MHz]	13.56	13.56	13.56
Material of active face	Plastic	Plastic	Plastic
Housing material	Plastic	Plastic	Plastic
Memory size [Byte]	128	128	2048
Memory type	EEPROM	EEPROM	FRAM
Chip type	NXP I-Code SLI/SL2	NXP I-Code SLI/SL2	Fujitsu MB89R118
Number of read operations	unlimited	unlimited	unlimited
Number of write operations	10 ⁵	10 ⁵	10 ¹⁰
Typical read time [ms/byte]	2	2	0.5
Typical write time [ms/byte]	3	3	0.5
Degree of protection	IP69K	IP69K	IP69K
Ambient temperature [°C]	-25 ...+85	-25 ...+85	-25 ...+85
Storage temperature range	140 °C (1 × 100 h)	140 °C (1 × 100 h)	140 °C (1 × 100 h)
Storage temperature [°C]	-45...+85	-45...+85	-45...+85
Special features	-	ATEX	-
Approvals	-	ATEX category II 2 G, Ex Zone 1 ATEX category II 2 D, Ex Zone 21	-

Dimension drawing

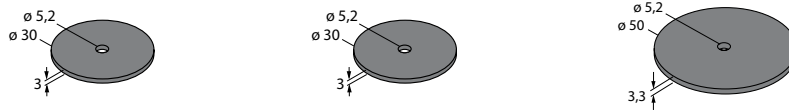

Type	TW-R30-K2-Ex	TW-R30-K9	TW-R50-B128
Ident no.	7030246	7030565	6900504
Operating frequency [MHz]	13.56	13.56	13.56
Material of active face	Plastic	Plastic, PA6	Plastic
Housing material	Plastic	Plastic, PA6, black	Plastic
Memory size [Byte]	2048	9216	128
Memory type	FRAM	FRAM	EEPROM
Chip type	Fujitsu MB89R118	Fujitsu MB89R112	NXP I-Code SLI/SL2
Number of read operations	unlimited	10 ¹²	unlimited
Number of write operations	10 ¹⁰	10 ¹²	10 ⁵
Typical read time [ms/byte]	0.5	0.5	2
Typical write time [ms/byte]	0.5	0.5	3
Degree of protection	IP69K	IP69K	IP69K
Ambient temperature [°C]	-25 ...+85	-20... +85 °C	-25 ...+85
Storage temperature range	140 °C (1 × 100 h)	–	140 °C (1 × 100 h)
Storage temperature [°C]	-45...+85	-55...+125 °C	-45...+85
Special features	ATEX	–	–
Approvals	ATEX category II 2 G, Ex Zone 1 ATEX category II 2 D, Ex Zone 21	–	–

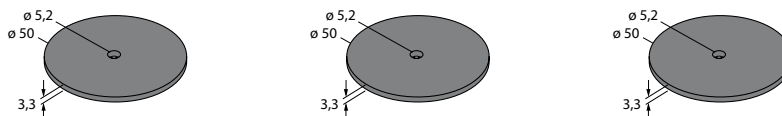
Dimension drawing

Type	TW-R50-B128-Ex	TW-R50-K2	TW-R50-K2-Ex
Ident no.	7030244	6900507	7030247
Operating frequency [MHz]	13.56	13.56	13.56
Material of active face	Plastic	Plastic	Plastic
Housing material	Plastic	Plastic	Plastic
Memory size [Byte]	128	2048	2048
Memory type	EEPROM	FRAM	FRAM
Chip type	NXP I-Code SLI/SL2	Fujitsu MB89R118	Fujitsu MB89R118
Number of read operations	unlimited	unlimited	unlimited
Number of write operations	10 ⁵	10 ¹⁰	10 ¹⁰
Typical read time [ms/byte]	2	0.5	0.5
Typical write time [ms/byte]	3	0.5	0.5
Degree of protection	IP69K	IP69K	IP69K
Ambient temperature [°C]	-25 ...+85	-25 ...+85	-25 ...+85
Storage temperature range	140 °C (1 × 100 h)	140 °C (1 × 100 h)	140 °C (1 × 100 h)
Storage temperature [°C]	-45...+85	-45...+85	-45...+85
Special features	ATEX	–	ATEX
Approvals	ATEX category II 2 G, Ex Zone 1 ATEX category II 2 D, Ex Zone 21	–	ATEX category II 2 G, Ex Zone 1 ATEX category II 2 D, Ex Zone 21

Dimension drawing

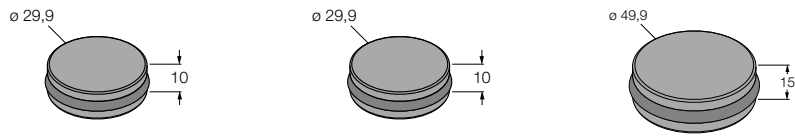

Type	TW-R30-M-B128	TW-R30-M-K2	TW-R50-M-B128
Ident no.	7030210	7030206	7030209
Operating frequency [MHz]	13.56	13.56	13.56
Material of active face	Plastic	Plastic	Plastic
Housing material	Plastic	Plastic	Plastic
Memory size [Byte]	128	2048	128
Memory type	EEPROM	FRAM	EEPROM
Chip type	NXP I-Code SLI/SL2	Fujitsu MB89R118	NXP I-Code SLI/SL2
Number of read operations	unlimited	unlimited	unlimited
Number of write operations	10 ⁵	10 ¹⁰	10 ⁵
Typical read time [ms/byte]	2	0.5	2
Typical write time [ms/byte]	3	0.5	3
Degree of protection	IP68	IP68	IP68
Ambient temperature [°C]	-25 ...+85	-25 ...+85	-25 ...+85
Storage temperature range	140 °C (1 × 100 h)	140 °C (1 × 100 h)	140 °C (1 × 100 h)
Storage temperature [°C]	-45...+85	-45...+85	-45...+85
Special features	-	-	-
Approvals	-	-	-

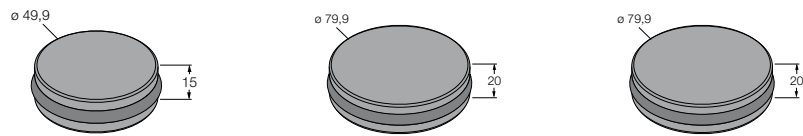
Dimension drawing

Type	TW-R50-M-K2	TW-R80-M-B128	TW-R80-M-K2
Ident no.	7030229	7030207	7030205
Operating frequency [MHz]	13.56	13.56	13.56
Material of active face	Plastic	Plastic	Plastic
Housing material	Plastic	Plastic	Plastic
Memory size [Byte]	2048	128	2048
Memory type	FRAM	EEPROM	FRAM
Chip type	Fujitsu MB89R118	NXP I-Code SLI/SL2	Fujitsu MB89R118
Number of read operations	unlimited	unlimited	unlimited
Number of write operations	10 ¹⁰	10 ⁵	10 ¹⁰
Typical read time [ms/byte]	0.5	2	0.5
Typical write time [ms/byte]	0.5	3	0.5
Degree of protection	IP68	IP68	IP68
Ambient temperature [°C]	-25 ...+85	-25 ...+85	-25 ...+85
Storage temperature range	140 °C (1 × 100 h)	140 °C (1 × 100 h)	140 °C (1 × 100 h)
Storage temperature [°C]	-45...+85	-45...+85	-45...+85

Dimension drawing

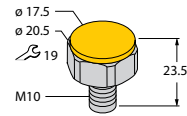
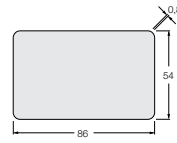
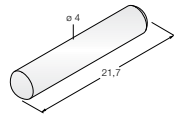

Type	TW-R4-22-B128	TW-L86-54-C-B128	TW-BD10X1.5-19-B128
Ident no.	7030237	6900479	6901384
Operating frequency [MHz]	13.56	13.56	13.56
Material of active face	Glass	Plastic	Plastic
Housing material	Glass	Plastic	Plastic
Memory size [Byte]	128	128	128
Memory type	EEPROM	EEPROM	EEPROM
Chip type	NXP I-Code SLI/SL2	NXP I-Code SLI/SL2	NXP I-Code SLI/SL2
Number of read operations	unlimited	unlimited	unlimited
Number of write operations	10 ⁵	10 ⁵	10 ⁵
Typical read time [ms/byte]	2	2	2
Typical write time [ms/byte]	3	3	3
Degree of protection	IP68	IP67	IP68
Ambient temperature [°C]	-25 ...+85	-25 ...+50	-25 ...+85
Storage temperature range	90 °C (1 × 1000 h) 120 °C (1 × 100 h)	-	-
Storage temperature [°C]	-40...+140	-25...+50	-45...+85
Special features	Glass tag, suitable for use in autoclave applications	Check card format	Screw tag, screw fitting in metal possible

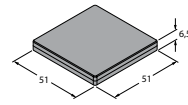
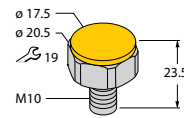
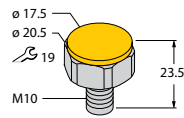
Dimension drawing

Type	TW-BS10X1.5-19-K2	TW-BV10X1.5-19-K2	TW-Q51WH-HT-B128
Ident no.	6901380	6901382	7030661
Operating frequency [MHz]	13.56	13.56	13.56
Material of active face	Plastic	Plastic	Plastic, PPS, black
Housing material	Metal/plastic	Metal/plastic	Plastic
Memory size [Byte]	2048	2048	128
Memory type	FRAM	FRAM	EEPROM
Chip type	Fujitsu MB89R118	Fujitsu MB89R118	NXP I-Code SLI-X
Number of read operations	unlimited	unlimited	Unlimited
Number of write operations	10 ¹⁰	10 ¹⁰	10 ⁵
Typical read time [ms/byte]	0.5	0.5	2
Typical write time [ms/byte]	0.5	0.5	3
Degree of protection	IP68	IP68	IP68
Ambient temperature [°C]	-25 ...+85	-25 ...+85	-25...+85 °C
Storage temperature range	-	-	200 °C, 60 minutes 220 °C, 45 minutes 240 °C, 30 minutes
Storage temperature [°C]	-45...+85	-45...+85	-55...+185 °C
Special features	Screw tag, screw fitting in metal possible	Screw tag, screw fitting in metal possible	High temperature

Dimension drawing

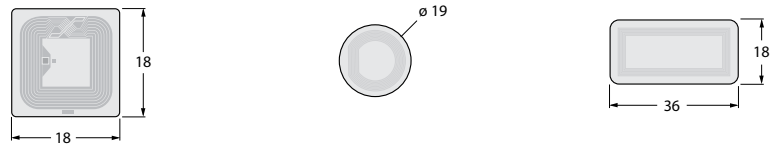

Type	TW-L18-18-F-B128	TW-L19-F-B128	TW-L36-18-F-B128
Ident no.	7030634	7030660	7030659
Operating frequency [MHz]	13.56	13.56	13.56
Material of active face	Plastic	Plastic	Plastic
Housing material	Plastic, PET	Plastic, PET	Plastic, PET
Memory size [Byte]	128	128	128
Memory type	EEPROM	EEPROM	EEPROM
Chip type	NXP I-Code SLI-X	NXP I-Code SLI-X	NXP I-Code SLI-X
Number of read operations	Unlimited	Unlimited	unlimited
Number of write operations	10 ⁵	10 ⁵	10 ⁵
Typical read time [ms/byte]	2	2	2
Typical write time [ms/byte]	3	3	3
Degree of protection	IP40	IP40	IP40
Ambient temperature [°C]	-20... +70 °C	-20... +70 °C	-20... +70 °C
Storage temperature range	-	-	-
Storage temperature [°C]	-20... +70 °C	-20... +70 °C	-20... +70 °C
Special features	Smart label, self-adhesive	Smart label, self-adhesive	Smart label, self-adhesive

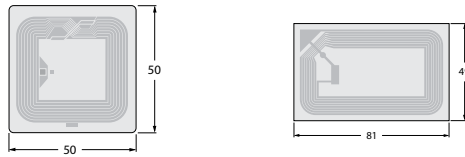
Dimension drawing

Type	TW-L50-50-P-B128	TW-L81-49-P-B128
Ident no.	7030635	7030260
Operating frequency [MHz]	13.56	13.56
Material of active face	Paper	Paper
Housing material	–	–
Memory size [Byte]	128	128
Memory type	EEPROM	EEPROM
Chip type	NXP I-Code SLI-X	NXP I-Code SLI/SL2
Number of read operations	Unlimited	Unlimited
Number of write operations	10 ⁵	10 ⁵
Typical read time [ms/byte]	2	2
Typical write time [ms/byte]	3	3
Degree of protection	IP40	IP40
Ambient temperature [°C]	-40... +85 °C	-20...+70 °C
Storage temperature range	–	–
Storage temperature [°C]	-40... +85 °C	-20...+70 °C
Special features	Smart label, self-adhesive	Smart label, self-adhesive

5.4.7 Accessories

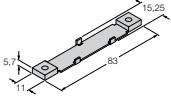
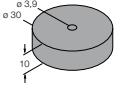
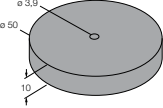
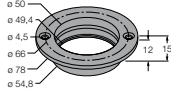
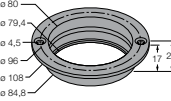
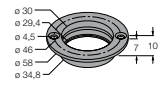
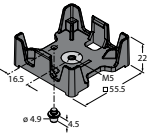
Dimension drawing	Type	Ident no.	Description
	TH-Q14L60	7030377	Metal clip with retaining magnets, mounting accessory for the TWxxx-Q14L60-M-B110 tag
	DS-R30	6900512	The spacer disc enables the indirect mounting of the tag on metal
	DS-R50	6900386	The spacer disc enables the indirect mounting of the tag on metal
	MF-R50	6901151	The flange enables the TW-R50-M-B128 (-K2) tag to be mounted on or in metal.
	MF-R80	6901152	The flange enables the TW-R80-M-B128 (-K2) tag to be mounted on or in metal.
	MF-R30	6901150	The flange enables the TW-R30-M-B128 (-K2) tag to be mounted on or in metal.
	TH-Q51T-HT	7030540	Holder with M5 threaded sleeve for screw fixing Q51 tags. The use of the 4.5 mm locking pin ensures that the tag is protected from being rotated. Suitable for mounting on metal. Suitable for repeated use at high temperatures. Only suitable for one-off mounting (snap fitting of tag in bracket). Using the bracket produces a 12 mm gap between the metal and the tag.

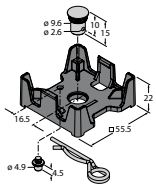

TH-Q51S-HT

7030541

Bracket with cotter pin fastening for Q51 tag. The use of the 4.5 mm locking pin ensures that tag is protected from being rotated. Suitable for mounting on metal. Suitable for repeated use at high temperatures. Only suitable for one-off mounting (snap fitting of tag in bracket). Using the bracket produces a 12 mm gap between the metal and the tag.

5.5 UHF Read/Write Heads

5.5.1 Type Code

T N LR ... - Q80 - H1147 - * / C53

T N LR ... Read/write head - Q80 Housing - H1147 Connector type -

- Working frequency**
 - blank 13.56 MHz
 - 865 865...868 MHz
 - 866 866...868 MHz
 - 902 902...928 MHz
 - 840/ 840.5...844.5 MHz &
 - 920 920.5...924.5 MHz
 - 902/ 902...907,5 MHz &
 - 915 915...928 MHz
 - 917 917...920.8 MHz
- Special range**
 - LR long range
 - SLR super long range
- Read/write heads, mounting condition**
 - B flush mountable
 - N non-flush mountable
- Turck RFID-System BL ident®**

- Housing**
 - CK40 rectangular 40 x 40 x 65 mm, variable orientation of active face
 - EM18WD thread M18, stainless steel, wash down (IP69K)
 - EM30WD thread M30, stainless steel, wash down (IP69K)
 - M18 thread M18
 - M30 thread M30
 - Q08 rectangular, 32 x 20 x 8 mm
 - Q14 rectangular 55.5 x 30 x 14 mm
 - Q42TWD rectangular, 68 x 42,5 x 42,5 mm, active face on top, wash down (IP69K)
 - Q80 rectangular, 114 x 80 x 40 mm
 - Q80L400 rectangular, 400 x 80 x 25 mm
 - Q80WD rectangular, 83 x 102 x 40 mm, wash down (IP69K)
 - Q120L130 rectangular, 120 x 130 x 60 mm
 - Q175L200 rectangular, 175 x 200 x 60 mm
 - Q175 rectangular, 175 x 200 x 60 mm
 - Q350 rectangular, 370 x 350 x 20 mm
 - S32XL ring shaped, 180 x 120 x 32 mm

- Connector**
 - 0.15-RS4.47T pigtail (150 mm) with male connector M12
 - H1147 connector M12 x 1
 - H1147L connector M12 x 1, lateral

*** Approvals / C53 Special Version**

- Approvals (optional)**
 - Ex approval for Ex-Area

- Special version**
 - C53 Bus-capable, setup of line topology with TBEN possible (HF Bus mode)

5.5.2 Features of the UHF Read/Write Heads

- Robust read/write heads in industrial design
- Read/write distances up to several meters (depending on ambient conditions)
- Compact design for restricted mounting requirements

5.5.3 Setup of the UHF Read/Write Heads

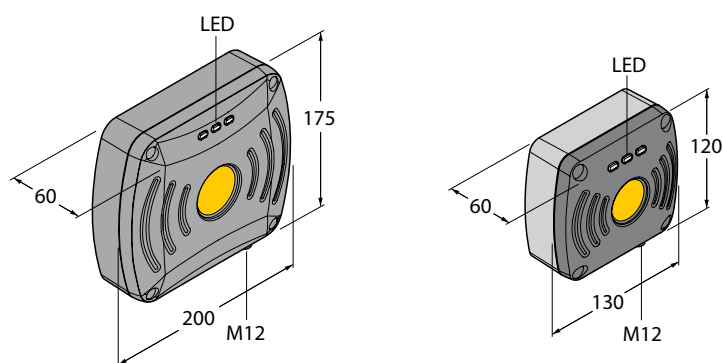

Fig. 18: Design of the BL ident® UHF read/write heads (Q175, Q120 designs)

5.5.4 Operating Principle

The read/write heads are used for contactless data exchange with tags. For this the controller sends commands and data via the interface to the read/write head and receives the corresponding response data from the read/write head. The reading of the IDs of all RFID tags in the read area or the writing of an RFID tag with a specific production date are examples of typical commands. To communicate with the tag, the data of the read/write head is coded and transferred via an electromagnetic field, which at the same time supplies the tags with power.

A read/write head contains a transmitter and a receiver, an interface to the interface and a coupling element (coil and dipole antenna) for communicating with the tag. Inductive coupling is used with devices for the HF range and electromagnetic wave propagation is used for the UHF range as the transmission procedure between read/write head and tag.

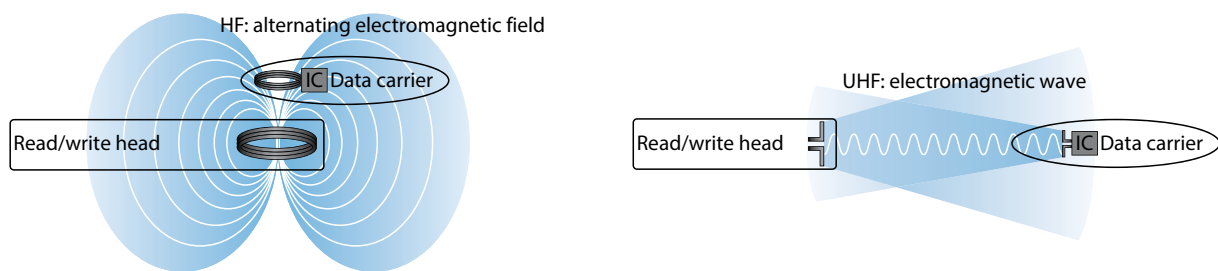

Fig. 19: HF RFID (left) and UHF RFID (right) operating principles

The coupling element of the read/write head generates an alternating electromagnetic field (HF) and electromagnetic waves (UHF). This produces a transmission window as a so-called air interface in which the data exchange with the tag takes place. The size of the transmission window depends on the combination of read/write head and tags, and with UHF on the relevant ambient conditions.

Each read/write head can communicate with a number of tags. This requires the read/write head and the tag to operate in the same frequency range. The detection ranges of the devices – depending on power and frequency – vary from a few millimeters to several meters. The specified maximum read/write distances only represent typical values under laboratory conditions without allowing for the effect of materials. The achievable distances may be different due to component tolerances, mounting location in the application, ambient conditions and the effect of materials (particularly metal and liquids).

5.5.5 Firmware Status

The following table describes the current firmware versions of the UHF read/write heads.

Read/write head	Firmware version
TN...-Q175 L200-H1147	FW 1.52
TN...-Q120L130 L200-H1174	

Date: 04/2017

5.5.6 Operating and Indication Elements

The devices are equipped with three LEDs to display the device status. The display functions can be configured for the specific application via the DTM. The LEDs have the following display functions as the factory default setting:

LED	Color	Status	Meaning
1 (operating status)	Green	Off	No operating voltage present
		Illuminated	Operating voltage is connected
		Goes out after 0.2 s	Tag detected
2 (radio field status)	Yellow	Off	Radio field is switched off
		Illuminated	Radio field is switched on
3 (error)	Red	Off	No internal error
		Illuminated	Internal error detected

5.5.7 Available Device Types

Dimension drawing

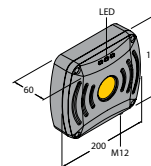
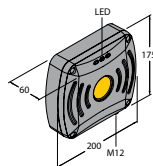
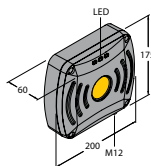

Type	TN865-Q175L200-H1147	TN902-Q175L200-H1147	TN840/920-Q175L200-H1147
Ident no.	7030452	7030457	7030466
Operating frequency [MHz]	865...868	902...928	920...925
Material of active face	Plastic	Plastic	Plastic
Mounting conditions	non-flush	non-flush	non-flush
Housing material	Aluminum	Aluminum	Aluminum
Housing length [mm]	200	200	200
Degree of protection	IP67	IP67	IP67
Ambient temperature [°C]	-25 ...+50	-25 ...+50	-25 ...+50

Dimension drawing

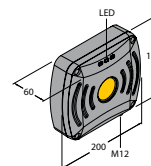
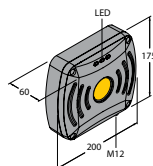
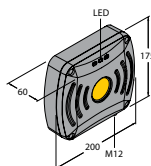

Type	TN917-Q175L200-H1147	TN866-Q175L200-H1147	TN902/915-Q175L200-H1147
Ident no.	7030513	7030669	7030668
Operating frequency [MHz]	917...920.8	866...867.6	902...907.5 and 915...926
Material of active face	Plastic	Plastic	Plastic
Mounting conditions	non-flush	non-flush	non-flush
Housing material	Aluminum	Aluminum	Aluminum
Housing length [mm]	200	200	200
Degree of protection	IP67	IP67	IP67
Ambient temperature [°C]	-25 ...+50	-25 ...+50	-25 ...+50

Dimension drawing

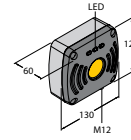
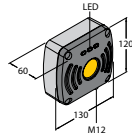
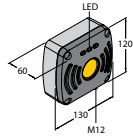

Type	TN865-Q120L130-H1147	TN902-Q120L130-H1147	TN840/920-Q120L130-H1147
Ident no.	7030520	7030535	7030536
Operating frequency [MHz]	865...868	902...928	920...925
Material of active face	Plastic	Plastic	Plastic
Mounting conditions	non-flush	non-flush	non-flush
Housing material	Aluminum	Aluminum	Aluminum
Housing length [mm]	130	130	130
Degree of protection	IP67	IP67	IP67
Ambient temperature [°C]	-25 ...+50	-25 ...+50	-25 ...+50

Dimension drawing

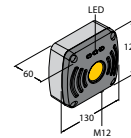
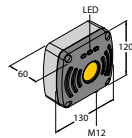
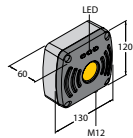

Type	TN917-Q120L130-H1147	TN866-Q120L130-H1147	TN902/915-Q120L130-H1147
Ident no.	7030537	7030671	7030670
Operating frequency [MHz]	917...920.8	866...867.5	902...907.5 and 915...926
Material of active face	Plastic	Plastic	Plastic
Mounting conditions	non-flush	non-flush	non-flush
Housing material	Aluminum	non-flush	non-flush
Housing length [mm]	130	130	130
Degree of protection	IP67	IP67	IP67
Ambient temperature [°C]	-25 ...+50	-25 ...+50	-25 ...+50

5.5.8 Combination of UHF Read/Write Heads and Tags

The UHF read/write heads form a transmission zone for which the size depends on the combination of read/write head and tag. The listed maximum read/write distances only represent typical values under laboratory conditions without the effect of materials.

The achievable distances may be different due to component tolerances, mounting location in the application, ambient conditions and the effect of materials (particularly metal). For this reason, the application must be tested in all cases under real conditions (particularly with read and write operations in motion).

Maximum Ranges of the UHF Read/Write Heads (Depending on Application Region)

Tag	Read/write head	Read/write head				Read/write head	Read/write head	Read/write head	Read/write head	Read/write head	Read/write head	Read/write head	Read/write head
		TN865-Q120L130-H1147 (Europe) 7030520	TN902-Q120L130-H1147 (USA) 7030535	TN840/920-Q120L130-H1147 (China) 7030536	TN917-Q120L130-H1147 (Korea) 7030537								
TW-865-868-Q14L60-M-B110 7030376	M	2.7	-	-	-	-	-	-	-	-	-	-	3.9
	L	0.7	-	-	-	-	-	-	-	-	-	-	1.0
TW865-868-R50-B110 7030257	M	1.4	-	-	-	-	-	-	-	-	-	-	1.8
	L	0.6	-	-	-	-	-	-	-	-	-	-	0.8
TW865-868-L80-20-T-B44 7030484	M	-	-	-	-	-	-	-	-	-	-	-	-
	L	2.1	-	-	-	-	-	-	-	-	-	-	3.0
TW902-928-R50-B110 7030404	M	-	1.8	2.0	2.2	-	-	-	2.6	2.8	2.9	-	-
	L	-	0.6	0.7	0.6	-	-	-	0.9	1.0	0.9	-	-
TW860-960-Q22L77-B-B112 7030458	M	-	-	-	-	-	-	-	-	-	-	-	-
	L	3.9	3.7	3.7	3.7	-	-	-	5.5	5.2	5.2	5.2	-
TW860-960-Q27L97-M-B112 7030464	M	4.5	4.9	5.4	5.2	-	-	-	5.9	6.8	7.7	7.4	-
	L	3.1	4.9	5.6	5.4	-	-	-	4.4	6.8	7.9	7.7	-
TW860-960-L97-15-F-B44 7030524	M	-	-	-	-	-	-	-	-	-	-	-	-
	L	5.7	5.1	5.1	4.9	-	-	-	8.1	7.2	7.2	6.9	-
TW860-960-L43-21-F-B38 7030592	M	-	-	-	-	-	-	-	-	-	-	-	-
	L	1.3	1.6	-	-	-	-	-	2.0	2.4	1.2	2.4	-
TW860-960-L73-17-F-B40 7030593	M	-	-	-	-	-	-	-	-	-	-	-	-
	L	1.6	2.9	-	-	-	-	-	2.3	4.1	4.6	4.6	-
TW860-960-L97-27-F-B44 7030618	M	-	-	-	-	-	-	-	-	-	-	-	-
	L	4.0	4.4	-	-	-	-	-	5.6	6.4	3.7	7.2	-
TW860-960-L97-27-P-B44 7030619	M	-	-	-	-	-	-	-	-	-	-	-	-
	L	4.0	4.4	-	-	-	-	-	5.6	6.4	3.7	7.2	-
TW860-960-L73-17-P-B40 7030620	M	-	-	-	-	-	-	-	-	-	-	-	-
	L	1.6	2.9	-	-	-	-	-	2.3	4.1	4.6	4.6	-
TW860-960-L54-34-F-B38 7030621	M	-	-	-	-	-	-	-	-	-	-	-	-
	L	2.8	2.3	-	-	-	-	-	4.7	3.3	3.3	3.3	-
TW860-960-L54-34-P-B38 7030622	M	-	-	-	-	-	-	-	-	-	-	-	-
	L	2.8	2.3	-	-	-	-	-	4.7	3.3	3.3	3.3	-
TW860-960-L43-21-P-B38 7030623	M	-	-	-	-	-	-	-	-	-	-	-	-
	L	1.3	1.6	-	-	-	-	-	2.0	2.4	1.2	2.4	-
TW860-960-L53-53-F-B44 7030624	M	-	-	-	-	-	-	-	-	-	-	-	-
	L	2.4	2.4	-	-	-	-	-	3.9	3.4	3.4	3.4	-
TW-865-928-Q20L58-B110 7030375	M	2.2	1.7	1.7	1.6	-	-	-	3.1	2.3	2.4	2.3	-
	L	1.5	1.5	1.7	1.5	-	-	-	2.2	2.1	2.4	2.1	-
TW865-928-L76-18-21-F-M-B110 7030380	M	3.7	3.2	2.7	3.0	-	-	-	5.2	4.5	3.8	4.2	-
	L	1.6	2.2	1.8	2.1	-	-	-	2.3	3.1	5.2	2.9	-

5.5.9 Accessories

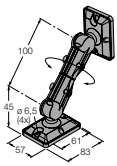
Dimension drawing	Type	Ident no.	Description
	RH-Q240L280/Q280L640	7030296	Arm bracket for UHF read/write heads

5.6 UHF Tags

5.6.1 Type Code

T **W** ... - **Q51** - **M** - **HT** - **B128** - **Ex**

T **W** ... **Data carrier** - **Q51** **Housing** - **M** **Features** -

- Working frequency
 - blank** 13.56 MHz
 - 865-868** 865...868 MHz
 - 865-928** 865...928 MHz
 - 860-960** 860...960 MHz
 - 902-928** 902...928 MHz
- Data carrier, memory access
 - W** read/write
 - R** read only
- Turck RFID-System BL ident®

- Housing
 - BD10X1.5-19** screw housing, plastic, M10 x 1.5, wrench size 19 mm
 - BS10X1.5-19** screw housing, metal/plastic, M10 x 1.5, wrench size 19 mm
 - BV10X1.5-19** screw housing, stainless steel/plastic, M10 x 1.5, wrench size 19 mm
 - I...** inlay & dimensions
 - L...** label & dimensions
 - Q...L...** rectangular & diameter
 - Q51** rectangular & lateral length: 51 mm
 - R...** round & diameter

- Features
 - C** cheque card format
 - F** foil data carrier
 - M** for direct mounting on metal
 - MF** for direct mounting on metal, foil shielded
 - P** paper data carrier

HT **High temperature (optional)** - **B128** **Memory capacity total** - **Ex** **Approvals**

- High temperature
 - HT** High temperature

- Memory capacity total (size)
 - B...** ... Byte
 - K...** ... kByte

- Approvals
 - Ex** Approval for Ex-Area

5.6.2 Features of the UHF Tags

- EEPROM tag with up to approx. 138 byte memory
- High temperature tags for use at -40...+240 °C, depending on ambient conditions
- Autoclave tags for use in pressurized hot water vapor at 121 °C
- Tags for direct mounting on metal
- Open and globally applicable standards (ISO 18000-6C, EPC Global Class1 Gen2)
- Optimized for small housing dimensions or high data transmission ranges
- Round, flat tags
- Smart label tags

Memory Module

Tags are available with an EEPROM memory. The memory size of the Turck tags is between 28 bytes and 138 bytes (up to 110 bytes of user data).

- EEPROM (electrically erasable programmable read only memory) tags can ensure an unlimited number of read operations and up to 10^5 write cycles.

Polarization of the Antenna

UHF tags normally have similar reception characteristics to a dipole antenna with a linear polarization. Depending on how the tag is fitted, horizontal, vertical or mixed polarization is used.

5.6.3 Setup of the UHF Tags

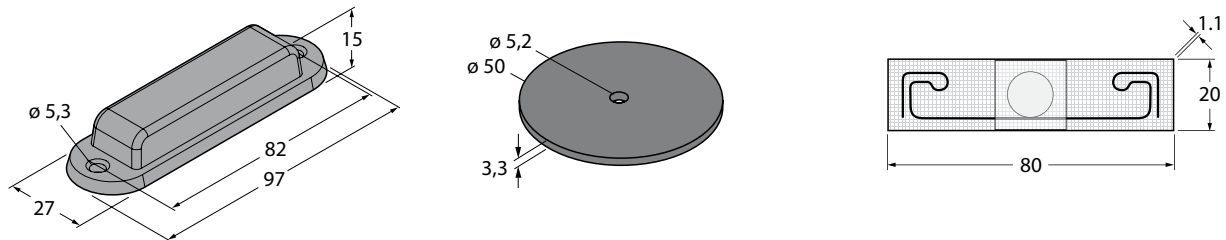

Fig. 20: UHF tags (examples)

Tags for a wide range of applications are available. Other properties of the tags include:

- Types for direct mounting on metal
- Types for particularly large temperature ranges, also high temperatures (-40... +240 °C)
- Type for use in autoclaves (pressurized steam up to +121 °C)
- Types as (printable) label (adhesive or inlay) in foil thickness

5.6.4 Operating Principle

An RFID tag is a mobile data memory consisting of a memory chip and a coupling element (coil or antenna). It can be written or read without contact in an RFID system. Tags with EEPROM and FRAM memories are available. Tags provide information on the object to which they are fitted, e.g. a unique identification number, batch number or specific production data. Prior to use, the tag is written with a worldwide uniquely assigned number, e.g. for UHF tags compliant with the EPCglobal Class 1 Gen 2 standard (ISO18000-6C) and for HF tags according to ISO 15693.

Turck tags are passive, i.e. they operate without the use of a battery and are powered by the magnetic or electromagnetic field generated by the read/write head. If the tag enters the transmission field of the read/write head, it is activated for writing and reading the data. To do this, the tag does not generate its own field but simply changes the field of the read/write head by modulating the load. For this a load resistor is switched on and off in time with the data to be transmitted, thus changing the mutual inductance of the HF tag or the properties of the wave reflected by the UHF tag. These changes are detected and evaluated by the read/write head.

The tags can be written to and read from without contact by a number of read/write heads. This requires the read/write heads and the tags to operate in the same frequency range. The detection ranges of the devices – depending on power and frequency – vary from a few millimeters to several meters. The specified maximum read/write distances only represent typical values under laboratory conditions without allowing for the effect of materials. The achievable distances may be different due to component tolerances, mounting location in the application, ambient conditions and the effect of materials (particularly metal and liquids).

5.6.5 User Data Areas of Tags

The UHF tag memory is divided into four logical banks in accordance with ISO 18000-6C (also called “domains”) and can consist of several blocks. Each block contains 2 bytes.



NOTICE

Incorrect writing to the tag

Possible malfunction of the tags

- Proceed with care when writing to the reserved area (bank address = 00) or to the first four bytes of the Ull memory (bank address = 01).

- Bank 00_{bin} – Reserved area: This bank contains the passwords for securing the memory and for deactivating the tag. The passwords for deactivating are stored in the memory addresses 00_{hex} to 1F_{hex}. The passwords for access protection are stored in the memory addresses 20_{hex} to 3F_{hex}. Memory access to this reserved area is normally executed with separate protocol commands.
- Bank 01_{bin} – EPC (electronic product code) or Ull (unique item identifier): This bank contains the essential identification data of the transponder. The 16-bit checksum (CRC) is located in the first data word (from address 00_{hex}). The second data word (= 2 bytes) contains specific tag control information (protocol control byte, from address 10_{hex}). The actual data area of the Ulls starts at address 20_{hex}. The tags are identified in the BL ident® system by means of the first eight bytes of the data area, i.e. from address 04_{hex} to 0C_{hex}.
- Bank 10_{bin} – TID (tag identification): This area contains one of three values for determining the class identification (E0_{hex}, E2_{hex} or E3_{hex}) in accordance with ISO/IEC 15963, contained in the memory addresses 00_{hex} to 07_{hex}. If the class is ID E0_{hex}, the TID contains a 48-bit serial number.
- Bank 11_{bin} – user area: This area is optional and contains a varying memory range for use as required by the user.

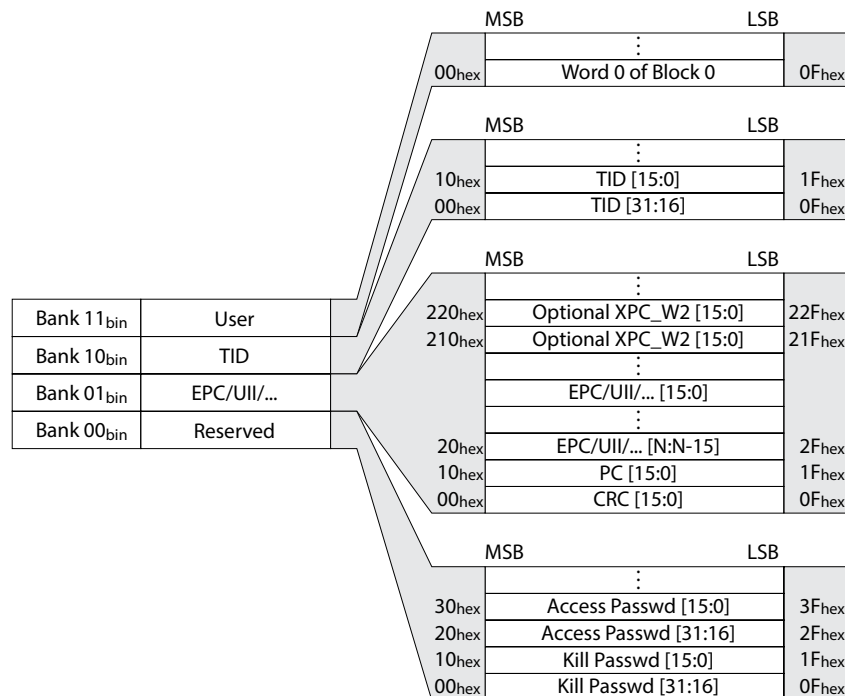

Fig. 21: Memory organization of the UHF tags

Turck offers BL ident® tags for the UHF range with the following chip types:

- EEPROM NXP U code
- EEPROM Impinj Monza®
- EEPROM Alien Higgs®



NOTE

The number of banks for the different chip types varies. The Impinj Monza® 5 therefore only has three areas (the user area is not provided), whilst the NXP-G2XM contains all four areas.

Overview of UHF Tags with Impinj Monza® 3 Chip

The type Impinj Monza® 3 UHF tags are provided with a UII memory area of 12 bytes. The following table describes the data structure of the tags.

Bank address [bin.]	Bank name	Memory address [hex.]	No. of bytes	Remark
10	TID	10...1F	2	0001 + model number
		00...0F	2	fixed = 1110001000000000
01	UII	20...7F	12	UII
		10...1F	2	Protocol control bits
		00...0F	2	Checksum CRC-16
00	Reserved	20...3F	4	Password for memory access
		00...1F	4	Password to deactivate the memory

Overview of UHF Tags with Impinj Monza® 4D Chip

The type Impinj Monza® 4D UHF tags are provided with a UII memory area of 16 bytes. The following table describes the data structure of the tags.

Bank address [bin.]	Bank name	Memory address [hex.]	No. of bytes	Remark
11	User	00...1F	4	freely usable
10	TID	30...5F	6	Serial number
		20...2F	2	extended TID header
		10...1F	2	Manufacturer ID + model number
		00...0F	2	11100010 + manufacturer ID
01	UII	20...9F	16	UII
		10...1F	2	Protocol control bits
		00...0F	2	Checksum CRC-16
00	Reserved	20...3F	4	Password for memory access
		00...1F	4	Password to deactivate the memory

Overview of UHF Tags with Impinj Monza® 4E Chip

The type Impinj Monza® 4E UHF tags are provided with a UII memory area of 62 bytes. The following table describes the data structure of the tags:

Bank address [bin.]	Bank name	Memory address [hex.]	No. of bytes	Remark
11	User	00...7F	16	freely usable
10	TID	30...5F	6	Serial number
		20...2F	2	extended TID header
		10...1F	2	Manufacturer ID + model number
		00...0F	2	11100010 + manufacturer ID
01	UII	20...20F	62	UII
		10...1F	2	Protocol control bits
		00...0F	2	Checksum CRC-16
00	Reserved	20...3F	4	Password for memory access
		00...1F	4	Password to deactivate the memory

Overview of UHF Tags with Impinj Monza® 4QT Chip – Private Mode

The type Impinj Monza® 4QT UHF tags in private mode are provided with a UII memory area of 16 bytes and a freely available user area of 64 bytes.

The following table describes the data structure of the tags.



NOTE

Further information on the “public” and “private” modes are provided in the data sheet of the ICs used.

Bank address [bin.]	Bank name	Memory address [hex.]	No. of bytes	Remark
11	User	00...1FF	64	freely usable
10	TID	60...BF	12	UII “public”
		30...5F	6	Serial number
		20...2F	2	extended TID header
		10...1F	2	Manufacturer ID + model number
		00...0F	2	11100010 + manufacturer ID
01	UII private	20...9F	16	UII
		10...1F	2	Protocol control bits
		00...0F	2	Checksum CRC-16
00	Reserved	20...3F	4	Password for memory access
		00...1F	4	Password to deactivate the memory

Overview of UHF Tags with Impinj Monza® 4QT Chip – Public Mode

NOTE

The following specifications for the Impinj Monza 4QT in public mode are only for information purposes since public mode is not supported by the BL ident® system.

Bank address [bin.]	Bank name	Memory address [hex.]	No. of bytes	Remark
10	TID	10...1F	2	Manufacturer ID + model number
		00...0F	2	11100010 + manufacturer ID
01	UII "public"	20...7F	12	UII
		10...1F	2	Protocol control bits
		00...0F	2	Checksum CRC-16
00	Reserved	20...3F	4	Password for memory access
		00...1F	4	Password to deactivate the memory

Overview of UHF Tags with Impinj Monza® 5 Chip

The type Impinj Monza® 5 UHF tags are provided with a UII memory area of 16 bytes. The following table describes the data structure of the tags.

Bank address [bin.]	Bank name	Memory address [hex.]	No. of bytes	Remark
10	TID	30...5F	6	Serial number
		20...2F	2	extended TID header
		10...1F	2	Model number
		00...0F	2	11100010 + manufacturer ID
01	UII	20...9F	16	UII
		10...1F	2	Protocol control bits
		00...0F	2	Checksum CRC-16
00	Reserved	20...3F	4	Password for memory access
		00...1F	4	Password to deactivate the memory

Overview of UHF Tags with Alien Higgs® 3 Chip

The type Alien Higgs® 3 UHF tags are provided with a UII memory area of 12 bytes and a freely available user area of 64 bytes. The following table describes the data structure of the tags.

Bank address [bin.]	Bank name	Memory address [hex.]	No. of bytes	Remark
11	User	00...1FF	64	freely usable
10	TID	60...BF	12	reserved
		20...5F	8	Serial number
		10...1F	2	Model number
		00...0F	2	Manufacturer ID
01	UII	20...7F	12	UII
		10...1F	2	Protocol control bits
		00...0F	2	Checksum CRC-16
00	Reserved	20...3F	4	Password for memory access
		00...1F	4	Password to deactivate the memory

Overview of theTags with Alien Higgs® 4 Chip

The UHF tags with Chip Alien Higgs® 4 are provided with a UII memory area of 16 bytes. The following table describes the data structure of the tags.

Bank address [bin.]	Bank name	Memory address [hex.]	No. of bytes	Remark
11	User	00...7F	16	freely usable
10	TID	60...BF	12	reserved
		20...5F	8	Serial number
		10...1F	2	Model number
		00...0F	2	Manufacturer ID
01	UII	20...9F	16	UII
		10...1F	2	Protocol control bits
		00...0F	2	Checksum CRC-16
00	Reserved	20...3F	4	Password for memory access
		00...1F	4	Password to deactivate the memory

Overview of UHF Tags with NXP U-Code G2XM/G2XL Chip

The type NXP U-Code G2XM/G2XL UHF tags are provided with a UII memory area of 30 bytes. The following table describes the data structure of the tags.

Bank address [bin.]	Bank name	Memory address [hex.]	No. of bytes	Remark
11	User	00...1FF	64	freely usable (only with NXP U-Code G2XM;) NXP U-Code G2XL has 0 bytes)
10	TID	20...3F	4	Serial number
		10...1F	2	Model number
		00...0F	2	Manufacturer ID, fixed 11100010
01	UII	20...10F	30	UII
		10...1F	2	Protocol control bits
		00...0F	2	Checksum CRC-16
00	Reserved	20...3F	4	Password for memory access
		00...1F	4	Password to deactivate the memory

Overview of UHF Tags with NXP U-Code G2IM Chip

The type NXP U-Code G2IM tags are provided with a UII memory area of 16 bytes, a freely available user area of 64 bytes and a user TID of 14 bytes. The following table describes the data structure of the tags.

Bank address [bin.]	Bank name	Memory address [hex.]	No. of bytes	Remark
11	User	00...27F	64	freely usable
10	TID	60...CF	14	User TID, freely usable
		30...5F	6	Serial number
		20...2F	2	extended TID header
		14...1F	2	Model number
		08...13	2	fixed 00000000110
		00...07	1	Manufacturer ID, fixed 11100010
01	UII	20...9F	16	UII
		10...1F	2	Protocol control bits
		00...0F	2	Checksum CRC-16
00	Reserved	20...3F	4	Password for memory access
		00...1F	4	Password to deactivate the memory

Overview of UHF Tags with NXP U-Code G2IL Chip

The type NXP U-Code G2IL UHF tags are provided with a UII memory area of 16 bytes. The following table describes the data structure of the tags.

Bank address [bin.]	Bank name	Memory address [hex.]	No. of bytes	Remark
10	TID	20...3F	6	Serial number
		20...2F	2	extended TID header
		14...1F	2	Model number
		00...13	2	11100010 + manufacturer ID
01	UII	200...20F	2	Configuration word
		20...9F	16	UII
		10...1F	2	Protocol control bits
		00...0F	2	Checksum CRC-16
00	Reserved	20...3F	4	Password for memory access
		00...1F	4	Password to deactivate the memory

5.6.6 Available Device Types

Dimension drawing

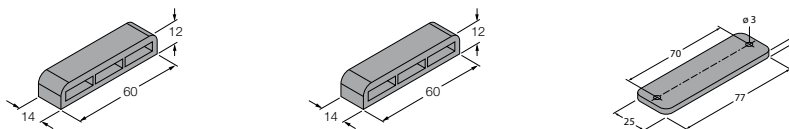

Type	TW865-868-Q14L60-M-B110	TW902-928-Q14L60-M-B110	TW860-960-Q25L77-B-B112
Ident no.	7030376	7030408	7030458
Operating frequency [MHz]	865...868	902...928	860...960
Material of active face	Plastic	Plastic	Plastic
Housing material	Plastic	Plastic	Plastic
Memory size [Byte]	110	110	112
Memory type	EEPROM	EEPROM	EEPROM
Chip type	NXP U-Code G2XM	NXP U-Code G2XM	Alien Higgs 3
Number of read operations	unlimited	unlimited	unlimited
Number of write operations	10 ⁴	10 ⁴	10 ⁵
Typical read time [ms/byte]	2	2	2
Typical write time [ms/byte]	3	3	3
Degree of protection	IP67	IP67	IP67
Ambient temperature [°C]	-35 ...+85	-35 ...+85	-40 ...+70
Storage temperature range [°C]	-	-	-
Storage temperature [°C]	-35...+85	-35...+85	-40...+70
Special features	Suitable for direct mounting on metal, suitable of outdoor applications	Suitable for direct mounting on metal, suitable of outdoor applications	-
Mechanical features	Suitable for direct mounting on metal	Suitable for direct mounting on metal	Flexible design for fixing on bent or irregular surfaces

Dimension drawing

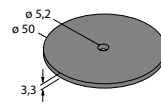
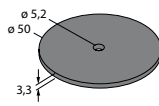
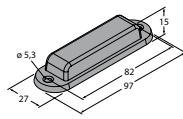

Type	TW860-960-Q27L97-M-B112	TW865-868-R50-B110	TW902-928-R50-B110
Ident no.	7030464	7030257	7030404
Operating frequency [MHz]	860...960	865...868	902...928
Material of active face	Plastic	Plastic	Plastic
Housing material	Plastic	Plastic	Plastic
Housing length [mm]	97	–	–
Memory size [Byte]	112	110	110
Memory type	EEPROM	EEPROM	EEPROM
Chip type	Impinj Monza 4QT	NXP U-Code G2XM	NXP U-Code G2XM
Number of read operations	unlimited	unlimited	unlimited
Number of write operations	10 ⁵	10 ⁴	10 ⁴
Typical read time [ms/byte]	2	2	2
Typical write time [ms/byte]	3	3	3
Degree of protection	IP69K	IP69K	IP69K
Ambient temperature [°C]	-40 ...+80	-20 ...+85	-20 ...+85
Storage temperature range [°C]	–	140 °C (1x100 h)	140 °C (1x100 h)
Storage temperature [°C]	-40...+80	-40...+90	-40...+90
Special features	Suitable for direct mounting on metal, suitable for outdoor applications	–	–
Mechanical features	Suitable for direct mounting on metal	–	–

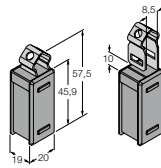
Dimension drawing

Type	TW865-928-Q20L58-B110
Ident no.	7030375
Operating frequency [MHz]	865...928
Material of active face	Plastic
Housing material	Plastic
Housing length [mm]	58
Memory size [Byte]	110
Memory type	EEPROM
Chip type	NXP U-Code G2XM
Number of read operations	unlimited
Number of write operations	10 ⁴
Typical read time [ms/byte]	2
Typical write time [ms/byte]	3
Degree of protection	IP67
Ambient temperature [°C]	-30 ...+70
Storage temperature range [°C]	-
Storage temperature [°C]	-30...+70
Special features	-
Mechanical features	Fixing via metal loop

Dimension drawing

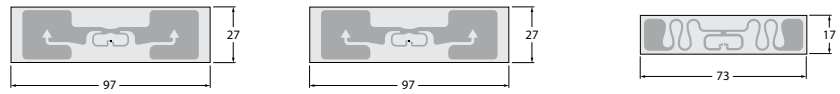

Type	TW860-960-L97-27-F-B44	TW860-960-L97-27-P-B44	TW860-960-L73-17-P-B40
Ident no.	7030618	7030619	7030620
Operating frequency [MHz]	860...960	860...960	860...960
Memory size [Byte]	44	44	40
Memory type	EEPROM	EEPROM	EEPROM
Chip type	Impinj Monza 4D	Impinj Monza 4D	Impinj Monza 5
Number of read operations	unlimited	unlimited	unlimited
Number of write operations	10 ⁵	10 ⁵	10 ⁵
Typical read time [ms/byte]	2	2	2
Typical write time [ms/byte]	3	3	3
Degree of protection	IP40	IP40	IP40
Ambient temperature [°C]	-40 ...+80	-40 ...+80	-40 ...+80
Storage temperature range [°C]	-	-	-
Storage temperature [°C]	-40...+85	-40...+85	-40...+85
Special features	Smart label, self-adhesive	Smart label, self-adhesive	Smart label, self-adhesive

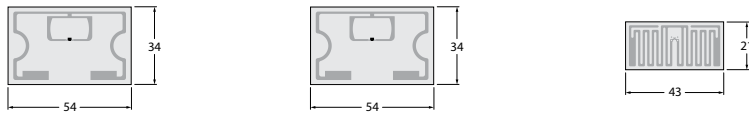
Dimension drawing

Type	TW860-960-L54-34-F-B38	TW860-960-L54-34-P-B38	TW860-960-L43-21-P-B38
Ident no.	7030621	7030622	7030623
Operating frequency [MHz]	860...960	860...960	860...960
Memory size [Byte]	38	38	38
Memory type	EEPROM	EEPROM	EEPROM
Chip type	NXP U-Code G2iL	NXP U-Code G2iL	NXP U-Code G2iL
Number of read operations	unlimited	unlimited	unlimited
Number of write operations	10 ⁵	10 ⁵	10 ⁵
Typical read time [ms/byte]	2	2	2
Typical write time [ms/byte]	3	3	3
Degree of protection	IP40	IP40	IP40
Ambient temperature [°C]	-40 ...+80	-40 ...+80	-40 ...+80
Storage temperature range [°C]	-	-	-
Storage temperature [°C]	-40...+85	-40...+85	-40...+85
Special features	Smart label, self-adhesive	Smart label, self-adhesive	Smart label, self-adhesive

Dimension drawing

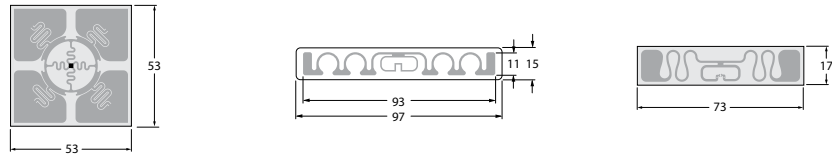

Type	TW860-960-L53-53-F-B44	TW860-960-L97-15-F-B44	TW860-960-L73-17-F-B40
Ident no.	7030624	7030524	7030593
Operating frequency [MHz]	860...960	860...960	860...960
Memory size [Byte]	44	44	40
Memory type	EEPROM	EEPROM	EEPROM
Chip type	Impinj Monza 4D	Impinj Monza 4D	Impinj Monza 5
Number of read operations	unlimited	unlimited	unlimited
Number of write operations	10 ⁵	10 ⁵	10 ⁵
Typical read time [ms/byte]	2	2	2
Typical write time [ms/byte]	3	3	3
Degree of protection	IP40	IP40	IP40
Ambient temperature [°C]	-40 ...+80	-10 ...+85	-40 ...+80
Storage temperature range [°C]	-	-	-
Storage temperature [°C]	-40...+85	-	-40...+85
Special features	Smart label, self-adhesive	Smart label, self-adhesive	Smart label, self-adhesive

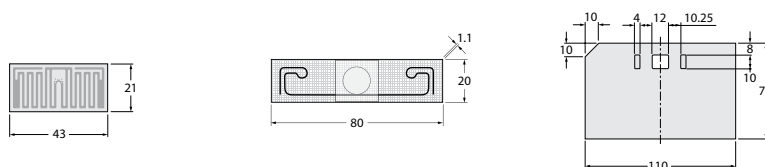
Dimension drawing

Type	TW860-960-L43-21-F-B38	TW865-868-L80-20-T-B44	TW860-960-L110-70-C-HT-B138
Ident no.	7030592	7030484	7030412
Operating frequency [MHz]	860...960	865...868	860...960
Memory size [Byte]	38	44	138
Memory type	EEPROM	EEPROM	EEPROM
Chip type	NXP U-Code G2iL	Impinj Monza 4D	NXP U-Code G2iM
Number of read operations	unlimited	unlimited	unlimited
Number of write operations	10 ⁵	10 ⁵	10 ⁴
Typical read time [ms/byte]	2	2	2
Typical write time [ms/byte]	3	3	3
Degree of protection	IP40	IP40	–
Ambient temperature [°C]	-40 ...+80	-20 ...+65	-25 ...+50
Storage temperature range [°C]	–	180 °C (up to 5 bar pressure and up to 10 min.)	–
Storage temperature [°C]	-40...+85	–	-25...+230
Special features	Smart label, self-adhesive	Smart label, self-adhesive	High temperature

5.7 Handhelds

5.7.1 Type Code

PD ident Handhelds

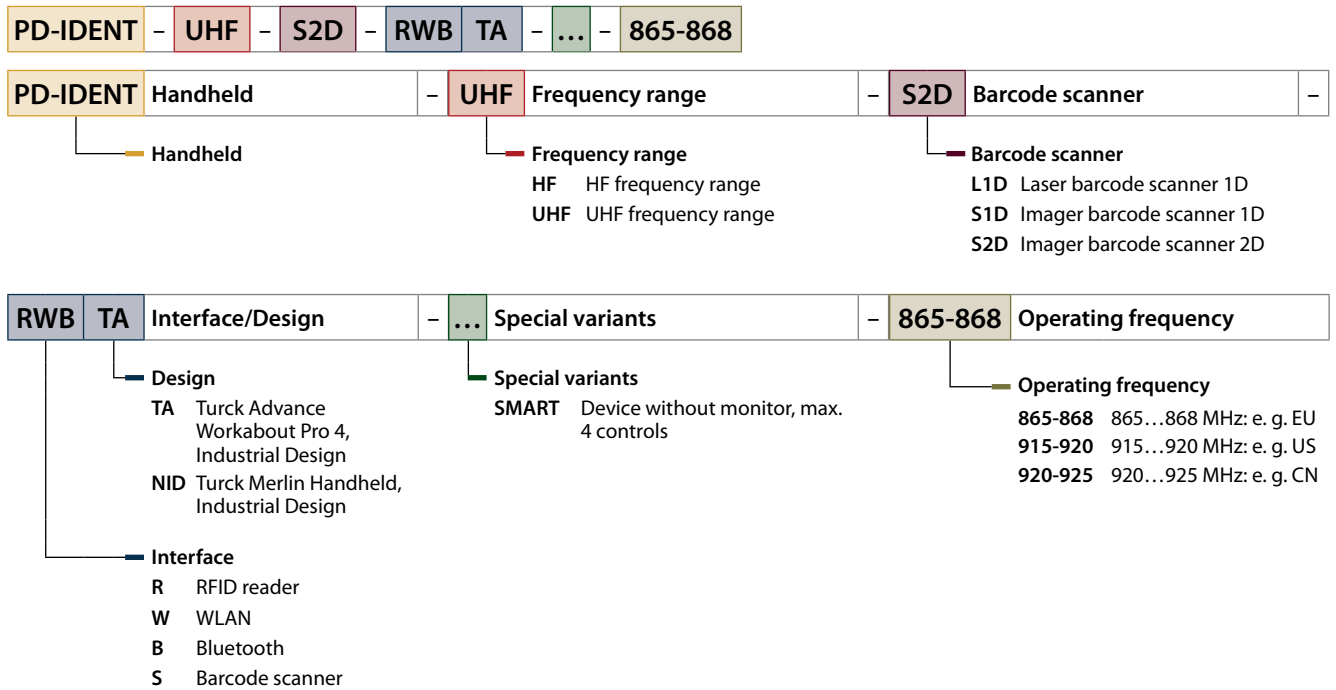

PD20 handhelds

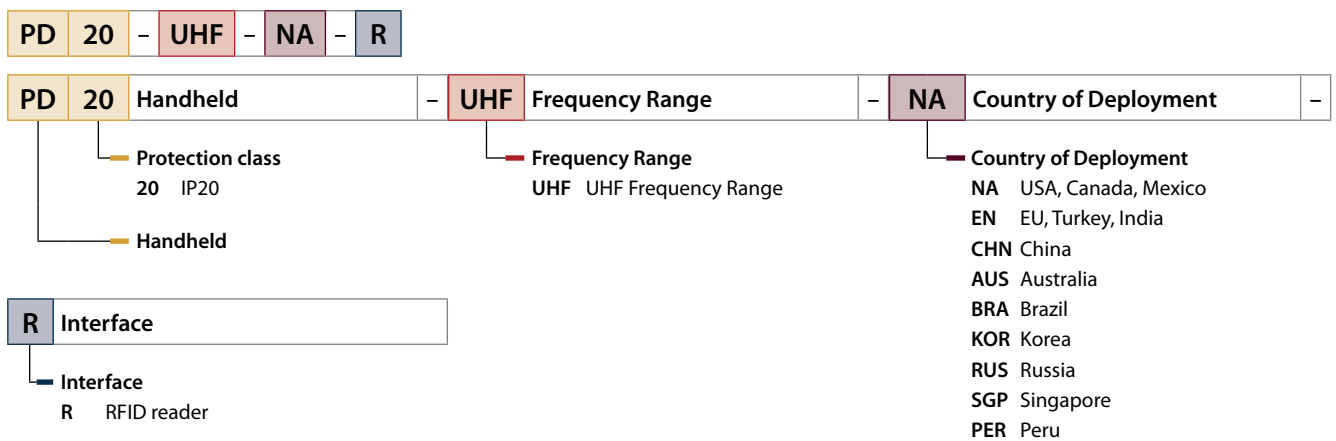

5.7.2 Features of the TA Handheld

- Available with HF or UHF antenna
- Mobile access to the data of a tag
- Suitable for indoor and outdoor use
- Alphanumeric keypad and touch screen display
- RFID and barcode combinable in one device
- Turck application software for reading and writing data
- Custom application software on request.
- Communication with other systems and databases
- Operating system: Windows CE
- IP65 and drop protection up to a height of 1.5 m

5.7.3 Features of SMART Handhelds

- Simple data acquisition
- Only 3 buttons
- Data transmission to iPhone and Android devices
- Combinable with barcode scanner

5.7.4 Features of the NID Handheld

- Handheld with cross dipole UHF antenna
- 2 W ERP RF power (1 W module) for a very large for read/write range
- Software-controlled antenna polarization (horizontal, vertical or cross polarized)
- 2D barcode scanner (reads 1D and 2D barcodes)
- Windows Embedded CE 6.0 operating system
- IP54 and drop protection up to a height of 1.5 m

5.7.5 Features of the PD20 Handheld

- Handheld with UHF antenna
- Connection to the host device via audio port
- incl. Turck RFID app (iOS, Android) for reading and writing of data

5.7.6 Setup of the Handhelds



Fig. 22: Handhelds (examples)

Turck offers different industrially robust mobile handheld for the mobile reading and writing of tags. The handhelds are available for the HF and UHF range.

5.7.7 TA Handhelds Operating Principle

TA handhelds enable tags to be read and written from any location. The read data is displayed on a touch screen. They can be edited via the handheld and written to a tag.

The handhelds are available for the following interfaces:

- Bluetooth
- Wifi
- RS232
- USB

Optional features:

- Barcode scanner (also for data matrix codes)
- Customized software solutions

5.7.8 Operating/Indication Elements of TA Handhelds

The handhelds are provided with a 3.7" touch screen display as well as an alphanumeric keypad (55 keys).

5.7.9 Functions and Operating Modes of TA Handhelds

Turck Application Software

- Language selection: German, English, French, Spanish, Italian
- Support of different tag types
- Multi-tag detection and tag selection
- Full addressing of the memory for reading and writing
- Support for ASCII, hexadecimal and decimal data formats

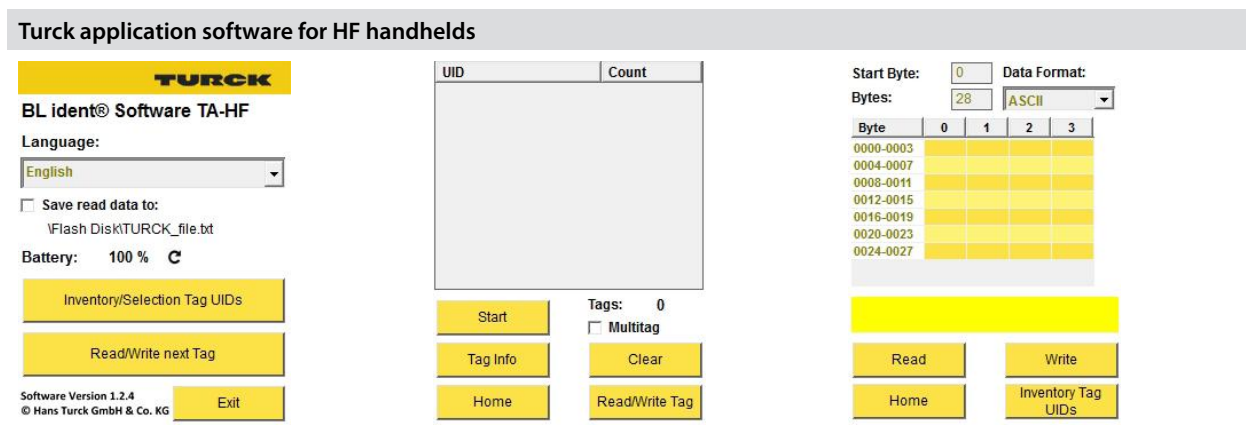

Fig. 23: BL ident® TA-HF software

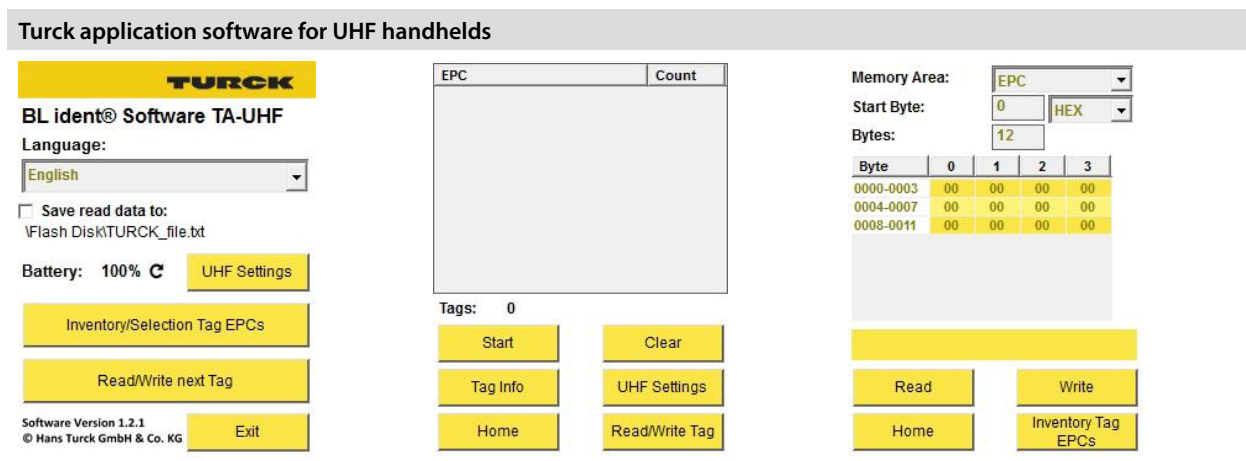

Fig. 24: BL ident® TA-UHF software

5.7.10 Customized Software Solutions

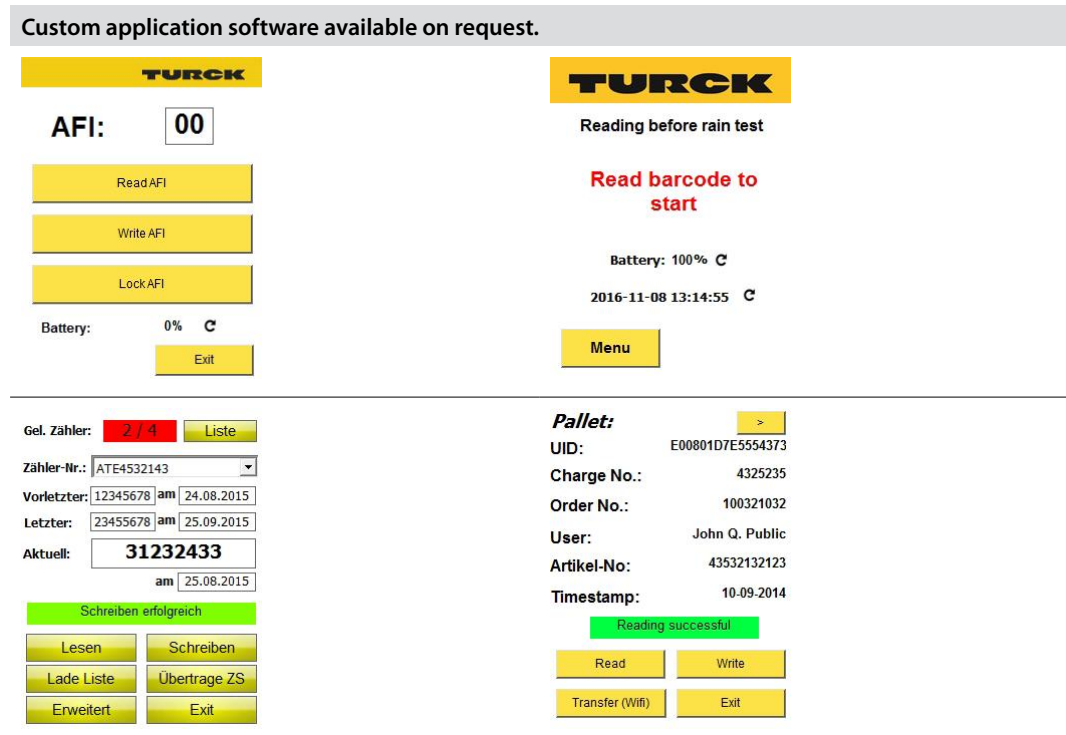

Fig. 25: Examples of customized software solutions

5.7.11 Available Device Types

Dimension drawing	Type	Ident no.	Description
	PD-IDENT-HF-RWBTA	7030601	<ul style="list-style-type: none"> - Handheld with HF antenna - Windows Embedded CE 6.0 operating system - Incl. Turck RFID TA-HF software (DE/EN/FR/IT/ES) for reading and writing tags - Custom application software on request - With Wifi 802.11a/b/g/n and Bluetooth wireless interface - Degree of protection IP65 - Withstands several knocks from a height of 1.5 m on smooth concrete - Incl. stylus holder, docking station with power supply unit, USB cable - Optional on request: Software development kit (SDK)
	PD-IDENT-HF-S2D-RWBTA	7030602	<ul style="list-style-type: none"> - Handheld with HF antenna - 2D barcode scanner (reads 1D and 2D barcodes) - Windows Embedded CE 6.0 operating system - Incl. Turck RFID TA-HF software (DE/EN/FR/IT/ES) for reading and writing tags - Custom application software on request - With Wifi 802.11a/b/g/n and Bluetooth wireless interface - Degree of protection IP65 - Withstands several knocks from a height of 1.5 m on smooth concrete - Incl. pistol grip, docking station with power supply unit, USB cable - Optional on request: Software development kit (SDK)
	PD-IDENT-HF-L1D-RBUP-SMART	7030564	<ul style="list-style-type: none"> - Handheld with HF antenna - Keypad function (HID) for wireless transmission of the read data via Bluetooth (also to IOS devices) or USB - Bidirectional communication with Android devices - With Barcode 1D laser scanner - Only three keys for easy operation - OEM configuration tool - Incl. power supply unit, battery, Bluetooth, USB transceiver and fixing clip
	PD-IDENT-UHF-RWBTA-865-868	7030636	<ul style="list-style-type: none"> - Handheld with UHF antenna - Windows Embedded CE 6.0 operating system - Incl. Turck RFID TA-UHF software for reading and writing tags - Custom application software on request - With Wifi 802.11a/b/g/n and Bluetooth wireless interface - Degree of protection IP65 - Withstands several knocks from a height of 1.5 m on smooth concrete - Incl. stylus holder, docking station with power supply unit, USB cable
	PD-IDENT-UHF-S2D-RWB-TA-865-868	7030637	<ul style="list-style-type: none"> - Handheld with UHF antenna - 2D barcode scanner (reads 1D and 2D barcodes) - Windows Embedded CE 6.0 operating system - Incl. Turck RFID TA-UHF software for reading and writing tags - Custom application software on request - With Wifi 802.11a/b/g/n and Bluetooth wireless interface - Degree of protection IP65 - Withstands several knocks from a height of 1.5 m on smooth concrete - Incl. pistol grip, docking station with power supply unit, USB cable

Dimension drawing	Type	Ident no.	Description
	PD-IDENT-UHF-RWBTA-902-928	7030642	<ul style="list-style-type: none"> – Handheld with UHF antenna – Windows Embedded CE 6.0 operating system – Incl. Turck RFID TA-UHF software (DE/EN/FR/IT/ES) for reading and writing tags – Custom application software on request – With Wifi 802.11a/b/g/n and Bluetooth wireless interface – Degree of protection IP65 – Withstands several falls from a height of 1.5 m – Incl. PD-IDENT-TA-4400 battery, PD-IDENT-TA-DOCK docking station with power supply unit and USB cable, operator stylus with PD-IDENT-TA-STYLUS-HOLDER-KIT holder
	PD-IDENT-UHF-S2D-RWB-TA-902-928	7030643	<ul style="list-style-type: none"> – Handheld with UHF antenna – 2D barcode scanner (reads 1D and 2D barcodes) – Windows Embedded CE 6.0 operating system – Incl. Turck RFID TA-UHF software (DE/EN/FR/IT/ES) for reading and writing tags – Custom application software on request – With Wifi 802.11a/b/g/n and Bluetooth wireless interface – Degree of protection IP65 – Withstands several falls from a height of 1.5 m – Incl. pistol grip, PD-IDENT-TA-4400 battery, PD-IDENT-TA-DOCK docking station with power supply unit and USB cable, operator stylus with PD-IDENT-TA-STYLUS-HOLDER-KIT holder
	PD-IDENT-UHF-RWBTA-920-925	7030644	<ul style="list-style-type: none"> – Handheld with UHF antenna – Windows Embedded CE 6.0 (CN) operating system – Incl. Turck RFID TA-UHF (EN/CN) software for reading and writing tags – Custom application software on request – With Wifi 802.11a/b/g/n and Bluetooth wireless interface – Degree of protection IP65 – Withstands several falls from a height of 1.5 m – Incl. PD-IDENT-TA-4400 battery, PD-IDENT-TA-DOCK docking station with power supply unit and USB cable, operator stylus with PD-IDENT-TA-STYLUS-HOLDER-KIT holder
	PD-IDENT-UHF-S2D-RWB-TA-920-925	7030645	<ul style="list-style-type: none"> – Handheld with UHF antenna – 2D barcode scanner (reads 1D and 2D barcodes) – Windows Embedded CE 6.0 (CN) operating system – Incl. Turck RFID TA-UHF (EN/CN) software for reading and writing tags – Custom application software on request – With Wifi 802.11a/b/g/n and Bluetooth wireless interface – Degree of protection IP65 – Withstands several falls from a height of 1.5 m – Incl. pistol grip, PD-IDENT-TA-4400 battery, PD-IDENT-TA-DOCK docking station with power supply unit and USB cable, operator stylus with PD-IDENT-TA-STYLUS-HOLDER-KIT holder
	PD-IDENT-UHF-S2D-RWBTNID-865-868	7030691	<ul style="list-style-type: none"> – Handheld with cross dipole UHF antenna – 2W ERP RF power (1 W module) for a very large for read/write range – Incl. Turck RFID TA-UHF software (DE/EN/FR/IT/ES) for reading and writing tags – Software-controlled antenna polarization, horizontal, vertical or cross polarized – 2D barcode scanner (reads 1D and 2D barcodes) – Windows Embedded CE 6.0 operating system – IP54 and drop protection up to a height of 1.5 m
	PD-IDENT-UHF-S2D-RWBNTIP-917-920	7030692	<ul style="list-style-type: none"> – Handheld with cross dipole UHF antenna – 1W ERP RF power (500 mW module) for a very large for read/write range – Incl. Turck RFID TA-UHF software (DE/EN/FR/IT/ES) for reading and writing tags – Software-controlled antenna polarization, horizontal, vertical or cross polarized – 2D barcode scanner (reads 1D and 2D barcodes) – Windows Embedded CE 6.0 operating system – IP54 and drop protection up to a height of 1.5 m

Dimension drawing	Type	Ident no.	Description
	PD-IDENT-UHF-S2D-RWBTNIP-902-928	7030707	<ul style="list-style-type: none"> - Handheld with cross dipole UHF antenna - 1W ERP RF power (500 mW module) for a very large for read/write range - Incl. Turck RFID TA-UHF software (DE/EN/FR/IT/ES) for reading and writing tags - Software-controlled antenna polarization, horizontal, vertical or cross polarized - 2D barcode scanner (reads 1D and 2D barcodes) - Windows Embedded CE 6.0 operating system - IP54 and drop protection up to a height of 1.5 m
	PD-IDENT-UHF-S2D-RWBTNIP-920-925	7030708	<ul style="list-style-type: none"> - Handheld with cross dipole UHF antenna - 1W ERP RF power (500 mW module) for a very large for read/write range - Incl. Turck RFID TA-UHF software (DE/EN/FR/IT/ES) for reading and writing tags - Software-controlled antenna polarization, horizontal, vertical or cross polarized - 2D barcode scanner (reads 1D and 2D barcodes) - Windows Embedded CE 6.0 operating system - IP54 and drop protection up to a height of 1.5 m
	PD20-UHF-NA-R	100000996	<ul style="list-style-type: none"> - Handheld with UHF antenna - 2W ERP RF power for a very large for read/write range - Connection to the host device via audio port - incl. Turck RFID app (iOS, Android) for reading and writing of data - Custom application software on request - Wifi 802.11a/b/g/n and wireless interface via connected host device - Degree of protection IP20 - Withstands several falls from a height of 1.5 m on smooth concrete - Permanent 1800 mAh lithium ion battery, approx. 2 hours of active scanning - Incl. Micro-B USB channel and power supply unit
	PD20-UHF-EU-R	100000995	<ul style="list-style-type: none"> - Handheld with UHF antenna - 2W ERP RF power for a very large for read/write range - Connection to the host device via audio port - incl. Turck RFID app (iOS, Android) for reading and writing of data - Custom application software on request - Wifi 802.11a/b/g/n and wireless interface via connected host device - Degree of protection IP20 - Withstands several falls from a height of 1.5 m on smooth concrete - Permanent 1800 mAh lithium ion battery, approx. 2 hours of active scanning - Incl. Micro-B USB channel and power supply unit
	PD20-UHF-CHN-R	100000997	<ul style="list-style-type: none"> - Handheld with UHF antenna - 2W ERP RF power for a very large for read/write range - Connection to the host device via audio port - incl. Turck RFID app (iOS, Android) for reading and writing of data - Custom application software on request - Wifi 802.11a/b/g/n and wireless interface via connected host device - Degree of protection IP20 - Withstands several falls from a height of 1.5 m on smooth concrete - Permanent 1800 mAh lithium ion battery, approx. 2 hours of active scanning - Incl. Micro-B USB channel and power supply unit

5.7.12 Accessories

Type	Ident no.	Description
PD-IDENT-TA-STYLUS-HOLDER-KIT	7030549	Stylus holder
PD-IDENT-TA-STYLUS	7030550	Spare styluses (5 pce)
PD-IDENT-TA-RS232	7030554	RS232 adapter cable for directly connecting the TA handheld to a device with an RS232 interface
PD-IDENT-TA-POWERSUPPLY	7030597	Power supply
PD-IDENT-TA-POUCH	7030548	Carrying bag for the TW and TA handhelds without pistol grip
PD-IDENT-TA-DOCK	7030596	Docking station incl. power supply unit
PD-IDENT-TA-4400	7030518	Spare battery 4400 mAh
PD-IDENT-SMART-1050	100000954	Spare battery 1050 mAh
PD-IDENT-NI-DOCK	7030712	Docking station incl. power supply unit
PD-IDENT-NID	100000816	Spare battery 2600 mAh

5.8 Connection Technology

5.8.1 Type Code

RK4.5T - 5 / S2503

RK4.5T	Connector type	-	5	Cable length	/	S2503	Connector quality
	Connector type RK4.5T female straight; 5-pin WK4.5T female angled; 5-pin			Cable length 0.3 0.3 m 2 2 m 5 5 m 10 10 m 25 25 m 50 50 m			Connector quality S2503 economic version: cable: UL 20549; cable jacket: PUR, black; qualified for drag chain use, oil-resistant, flexible

5.8.2 Features

- Pre-assembled fieldbus and connection cables
- Connection accessories for bus and power supply
- Pre-assembled cables for connecting interface and read/write head
- Connection and extension cordsets for the food sector
- Cable length to the read/write head up to 50 m

5.8.3 Connection Technology Design

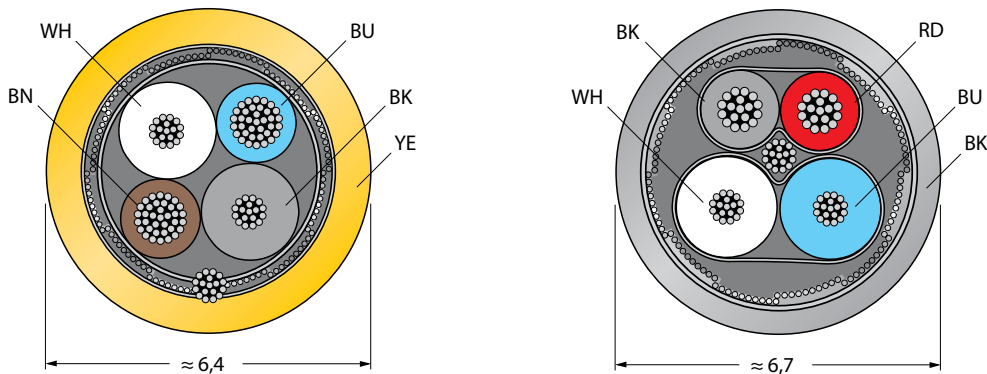
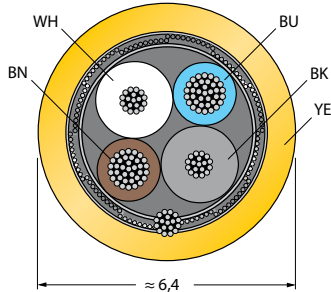

Fig. 26: Wiring diagrams of RFID cables, standard type (left), economy type (right)

5.8.4 Available Device Types

Standard Type

Wiring diagram



Technical data

4-pole, AWG 224 / AWG 22
 Sheathing material: PUR, color: yellow
 halogen free, LABS free
 Shield: Aluminum foil, tinned plated copper braid
 Sheath diameter: 6.4 mm
 Suitable for trailing applications, oil resistant, highly flexible
 Cable UL Style 20963

Cable type	S2500
Cable sheath	PUR, yellow
Cable diameter	Ø 6.4 mm
Shielding	Yes
Core cross section	2 x 0.2 mm ²
DC resistance (loop)	103 Ω /km
Core cross section	2 x 0.34 mm ²
Suitable for trailing cables	Yes
Halogen free	Yes
Connectors	Male/female connector, M12 x 1, straight/angled
Types	RK4.5T, RS4.5T, WK4.5T
Number of poles	5
Contacts	Metal, CuZn, gold-plated
Contact carrier	Plastic, CuZn, black
Grip body	Plastic, TPU, black
Coupling nut/screw	Metal, CuZn-Ni, nickel-plated
Protection class	IP67
Rated voltage	30 V
Ambient temperature	
at rest	-40 ... 90 °C
when moving	-25 ... 90 °C

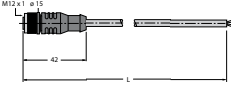
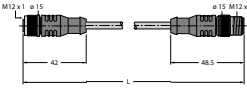
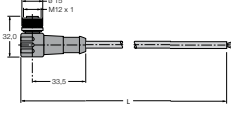
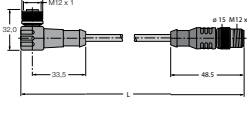
Dimension drawing	Cable length [m]	Ident no.	Type
	100	8036048	KABEL-BLIDENT-100M
	2	8035244	RK4.5T-2/S2500
	5	6699206	RK4.5T-5/S2500
	10	6699207	RK4.5T-10/S2500
	25	6638421	RK4.5T-25/S2500
	50	6699422	RK4.5T-50/S2500
	0.3	6699210	RK4.5T-0.3-RS4.5T/S2500
	2	6699200	RK4.5T-2-RS4.5T/S2500
	5	6699201	RK4.5T-5-RS4.5T/S2500
	10	6699202	RK4.5T-10-RS4.5T/S2500
	25	6699211	RK4.5T-25-RS4.5T/S2500
	50	8035246	RK4.5T-50-RS4.5T/S2500
	2	8035245	WK4.5T-2/S2500
	5	6699208	WK4.5T-5/S2500
	10	6699209	WK4.5T-10/S2500
	25	6699423	WK4.5T-25/S2500
	50	6699424	WK4.5T-50/S2500
	2	6699203	WK4.5T-2-RS4.5T/S2500
	5	6699204	WK4.5T-5-RS4.5T/S2500
	10	6699205	WK4.5T-10-RS4.5T/S2500
	25	6638425	WK4.5T-25-RS4.5T/S2500
	50	6638426	WK4.5T-50-RS4.5T/S2500

ECO Version

Wiring diagram

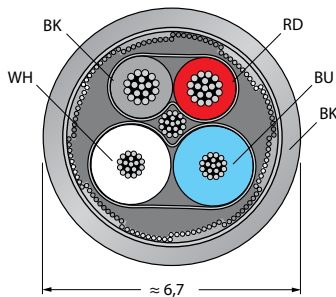

Technical data

4-pole, AWG 19/24 (data cable), AWG 19/22 (power supply cable)
 Sheathing material: PUR, black
 halogen free, LABS free
 Shield: Aluminum foil, tinned plated copper braid
 Sheath diameter: 6.7 mm
 Suitable for trailing applications, oil resistant, highly flexible
 Cable UL Style 20549

Cable type	S2503
Cable sheath	PUR, black
Cable diameter	Ø 6.7 mm
Shielding	Yes
Core cross section	2 x 0.25 mm ²
DC resistance (loop)	164 Ω /km
Core cross section	2 x 0.34 mm ²
Suitable for trailing cables	Yes
Connectors	Male/female connector, M12 x 1, straight/angled
Types	RK4.5T, RS4.5T, WK4.5T
Number of poles	5
Contacts	Metal, CuZn, gold-plated
Contact carrier	Plastic, CuZn, black
Grip body	Plastic, TPU, black
Coupling nut/screw	Metal, CuZn-Ni, nickel-plated
Protection class	IP67
Rated voltage	300 V
Ambient temperature	
at rest	-50 ... 80 °C
when moving	-25 ... 80 °C

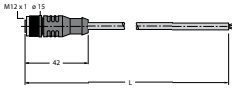
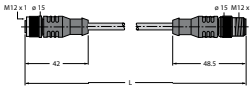
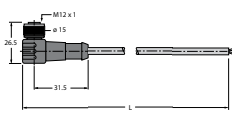
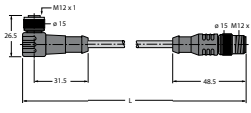
Dimension drawing	Cable length [m]	Ident no.	Type
	100	7030351	KABEL-E-BLIDENT-100M
	2	7030341	RK4.5T-2/S2503
	5	7030342	RK4.5T-5/S2503
	10	7030343	RK4.5T-10/S2503
	25	7030344	RK4.5T-25/S2503
	50	7030345	RK4.5T-50/S2503
	2	7030331	RK4.5T-2-RS4.5T/S2503
	5	7030332	RK4.5T-5-RS4.5T/S2503
	10	7030333	RK4.5T-10-RS4.5T/S2503
	25	7030334	RK4.5T-25-RS4.5T/S2503
	50	7030335	RK4.5T-50-RS4.5T/S2503
	2	7030346	WK4.5T-2/S2503
	5	7030347	WK4.5T-5/S2503
	10	7030348	WK4.5T-10/S2503
	25	7030349	WK4.5T-25/S2503
	50	7030350	WK4.5T-50/S2503
	2	7030336	WK4.5T-2-RS4.5T/S2503
	5	7030337	WK4.5T-5-RS4.5T/S2503
	10	7030338	WK4.5T-10-RS4.5T/S2503
	25	7030339	WK4.5T-25-RS4.5T/S2503
	50	7030340	WK4.5T-50-RS4.5T/S2503

Versions for the Food Sector

Wiring diagram

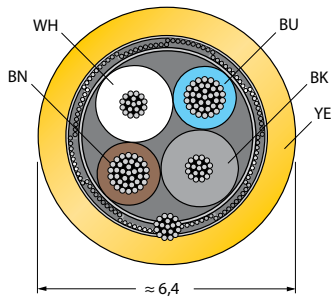

Technical data

The new standard for the food industry
 Resistant to all typical acids and alkali cleaning agents and disinfectants
 Degree of protection IP67/IP69K
 No hardening, no loss of color thanks to cleaning agent resistant PVC free plastics
 Also with other cable material lengths

Cable type	FB
Cable sheath	PP, yellow
Cable diameter	Ø 6.4 mm
Core cross section	0.25 mm ²
Connectors	Female connector, M12 x 1, straight/angled
Types	RK4.5T, WK4.5T
Number of poles	5
Contacts	Metal, CuZn, gold-plated
Contact carrier	Plastic, CuZn, black
Grip body	Plastic, PP, white
Coupling nut/screw	Stainless steel, 1.4404
Current carrying capacity	4 A
Protection class	IP67, IP69K (screwed)
Rated voltage	max. 250 V
Ambient temperature	
when moving	-25 ... 90 °C

Dimension drawing

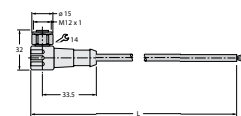
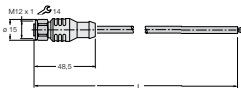

Cable length [m]	Ident no.	Type
5	7030281	FB-RK4.5T-5/S2500
10	7030282	FB-RK4.5T-10/S2500
25	7030283	FB-RK4.5T-25/S2500
50	7030284	FB-RK4.5T-50/S2500
5	7030285	FB-WK4.5T-5/S2500
10	7030286	FB-WK4.5T-10/S2500
25	7030287	FB-WK4.5T-25/S2500
50	7030288	FB-WK4.5T-50/S2500

5.9 BL ident® HF Simulator

The BL ident® Simulator enables you to simulate your individual application, combine different read/write heads and tags, and make the correct pre-selection for a system.

The simulator can be accessed as an online application at the following address:

<http://pdb.turck.de/en/DE/rfid/simulator>

The Simulator enables you to set application parameters for speed, range and data capacity and change the values. This shows the possibilities and limits of the particular combination of read/write heads and tags.

As well as simulating the application, the Simulator also shows the relevant data sheets and documents. The application draws on the data of the Turck product database and thus always supplies the most up-to-date data.



NOTE

The maximum read/write distance and the length of the transmission zone only represent typical values under laboratory conditions. The achievable distances may vary by up to 50 % due to component tolerances, mounting location in the application, ambient conditions and the effect of materials (particularly metal and liquids).

- The application must be tested particularly for read and write operations with tags in motion.
- Keep the recommended distance of tag to the read/write head.

In this way you ensure reliable read/write operations in the sensing range despite any deviations.



Fig. 27: BL ident® Simulator

6 Planning and Preparing the Use of a BL ident® System

The following information provides help in selecting the appropriate BL ident® system components for your application. General selection criteria include:

- Mechanical dimensions
- Distance of tags to read/write heads for read and write operations
- Tolerances in the mechanical guidance
- Static and/or dynamic transfer of data
- Data volume to be transferred
- Speed of dynamic read and write operations (on the fly)
- Use in explosion hazardous areas
- Effects and interference from materials
- Ambient conditions such as hazardous areas, humidity, temperature, effect of chemicals etc.

Important criteria for selecting read/write heads:

- Mechanical dimensions
- Required transmission zone
- Size of the tag used

Important criteria for selecting interfaces:

- Degree of protection
- Fieldbus
- Number of channels

6.1 Clarify Requirements of HF Applications

6.1.1 Transmission Frequency

The BL ident® HF system operates at a transmission frequency of 13.56 MHz between the tags and the read/write heads.

HF RFID systems are largely insensitive to electromagnetic interference and can be run parallel to UHF RFID systems in an installation.

6.1.2 Lifespan of the Tags

The passive tags do not require any batteries. Their lifespan is defined by the number of possible read/write operations.

- FRAM tags with 2K memory allow 10^{10} read and write operations each.
- FRAM tags with 8K memory allow 10^{12} read and write operations each.
- EEPROM tags ensure an unlimited number of read operations and 10^4 or 10^5 write operations.

6.1.3 Degree of Protection

Read/write heads with a high mechanical degree of protection (e.g. IP67/IP69K) are available for harsh industrial conditions or wash-down applications. Temperature-resistant tags up to 240°C are available for the high temperature range.

The interfaces for connecting a fieldbus system are offered in degrees of protection IP20 and IP67. The BL ident® product range also includes the appropriate connection cables in a suitable degree of protection.

6.1.4 Compatibility

Controller Systems

The BL ident® system is compatible with several different fieldbus controller systems. The modular design allows the system to be adapted to the selected fieldbus system. This enables it to be integrated easily in existing applications.

The BL ident® system supports the following fieldbus controller systems:

- PROFIBUS-DP
- DeviceNet™
- CANopen
- Modbus TCP
- EtherNet/IP™
- PROFINET
- EtherCAT®

BL ident® systems can be integrated into (existing) fieldbus systems. This makes it possible to network multiple BL ident® systems.

The guidelines for the maximum expansion of the fieldbus system used apply. Further information is provided in the startup manual (see also chapter “Other documents”).

Interoperability

A combination with systems of other suppliers is always possible thanks to international standards as well as standard technologies for the RFID sector.

The TURCK RFID system is optimized for the combination of BL ident® read/write heads, tags and interface modules. Different performance characteristics must be expected when combined with the devices of other manufacturers.

6.1.5 Transmission Zone and Read/Write Distance

The read/write head generates an alternating inductive field in the HF band. The recommended read/write distance depends on the combination of tag and read/write head. The distribution of the alternating field depends on the type of antennas in the tag and the read/write head.

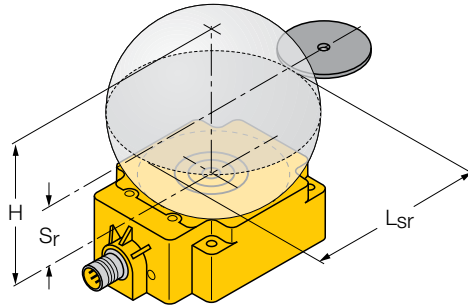

Fig. 28: Transmission zone in the HF range

A data exchange is only possible in the transmission zone. The L_{sr} (length of the transmission zone) and S_r (recommended read/write distance) are used to identify the transmission zone more precisely. The width of the transmission zone is reduced the greater the distance is between the tag and the read/write head, and is reduced to a point at limit distance H. The greater the distance, the less data can be transferred or the speed at which the read/write head is moved past must be reduced.

Length of the HF Transmission Zone and Width Offset

The length of the transmission zone L_{sr} depends on the combination of tag and read/write head.

The width offset is particularly important for the tolerance of a mechanical track guidance. An illustration of this dependency is shown in the BL ident® Simulator at www.turck.com.

6.1.6 Minimum Distance of Tag and Read/Write Head

With BL ident® a minimum distance between the tag and the read/write head is not necessary.

6.1.7 Permissible Motion Direction and Alignment of the Tags

The tags can move over the read/write head in any direction of movement if they are aligned parallel to the read/write head.

The TW-R...-M-B146 and TW-R4-22-B128 tags must be aligned to the read/write head in order to achieve the maximum transmission zone.

6.1.8 Reading and Writing in Static Mode

In static mode, data exchange is possible up to the area of limit distance H (see Fig. 28) if the tag is positioned precisely over the read/write head.

6.1.9 Reading and Writing in Dynamic Mode (on the Fly)

In dynamic mode the tag moves past the read/write head. A data exchange is only possible in the transmission zone.

6.1.10 Read Time/Write Time

The tag must be located in the sensing range of the read/write head for a specific time in order for all the required data to be read and written reliably. This read or write time depends on the following factors:

- Command type (write or read)
- Memory type of the tag (EEPROM or FRAM)
- Data volume
- Increase in sensing range (resulting from the combination of the type of read/write head and the tag, see chapter “Operating data”)

Write and read operations can be disturbed by the following factors:

- Electromagnetic interference (see chapter “Ensuring electromagnetic compatibility”)
- Damping of the electromagnetic field (range reduction)

The following sections show the time required for reading or writing a specific data volume. The write-read time required depends on the memory type of the tag.

Turck offers BL ident® tags for the HF range with the following memory types:

- EEPROM-I-Code SL2
- FRAM

EEPROM Tags

The EEPROM tag is divided into 4 byte data blocks.

The start address and length of the read/written bytes can be selected as required within the user data range.

Access to the user data range is only possible in blocks. This has an effect on the required read or write time: For example, no time saving is made if less than 4 bytes are to be read. The start addresses of the blocks are 0, 4, 8, 12...

Example: If 5 is selected as a start address and the length of the bytes to be read is 4, two blocks are processed.



NOTE

- Only enter multiples of 4 as the start address and the length of the bytes to be read/written. The start address and the length of the read/written bytes are attributes of the write and read commands.
 - When selecting the data memory range, give preference to the lower addresses.
-

The following diagrams apply if the instructions for time-critical applications are observed

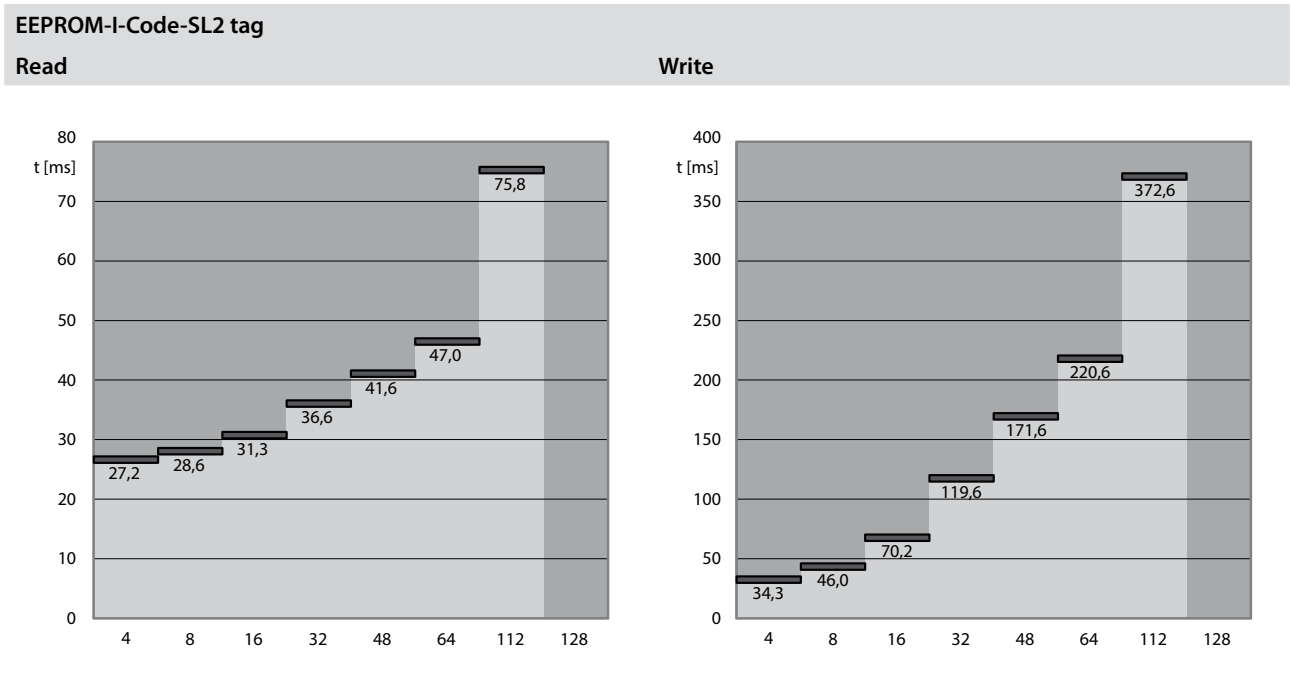

Fig. 29: Dwell times for reading and writing of EEPROM-I-Code-SL2 tags

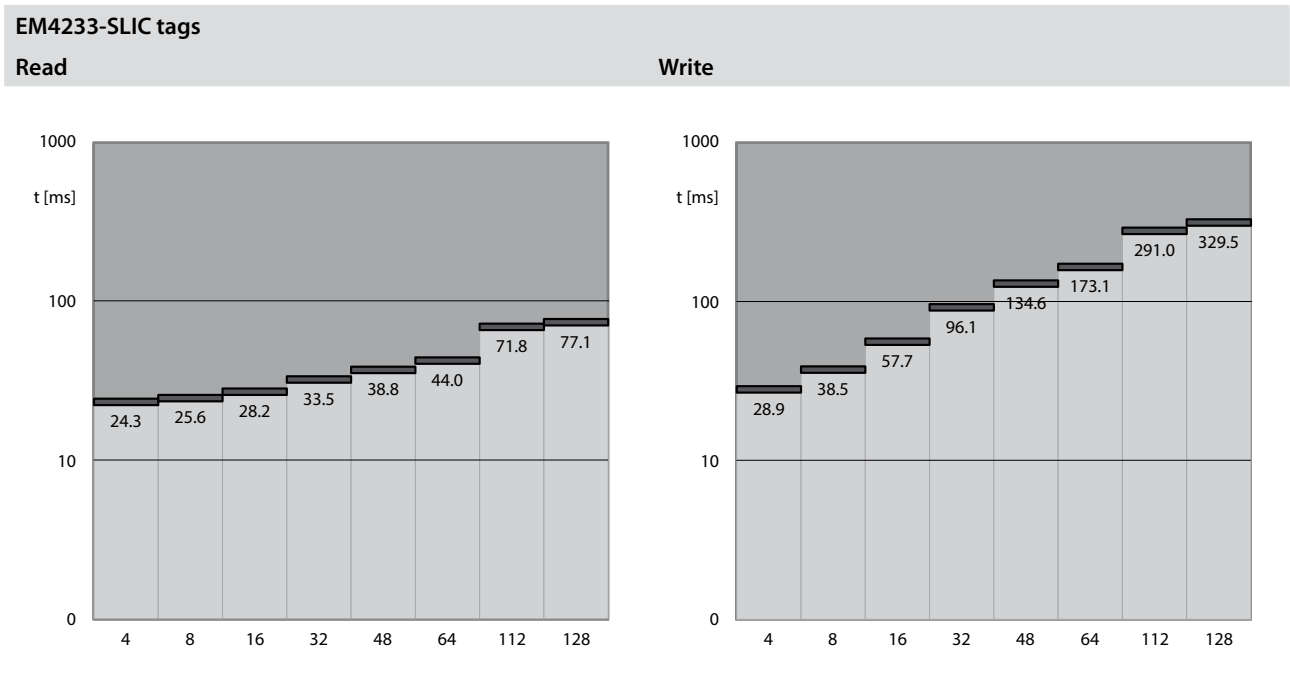

Fig. 30: Dwell times for reading and writing of EM4233SLIC tags

FRAM Tags

The FRAM tag is divided into 8 byte data blocks.

The start address and length of the read/written bytes can be selected as required within the user data range.

Access to the user data range is only possible in blocks. This has an effect on the required read or write time: For example, no time saving is made if less than 8 bytes are to be read. The start addresses of the blocks are 8, 16, 24, 32...

Example: If 19 is selected as a start address and the length of the bytes to be read is 4, two blocks are processed.



NOTE

- Only enter multiples of 4 as the start address and the length of the bytes to be read/written. The start address and the length of the read/written bytes are attributes of the write and read commands.
- When selecting the data memory range, give preference to the lower addresses.

The following diagrams apply if the instructions for time-critical applications are observed.

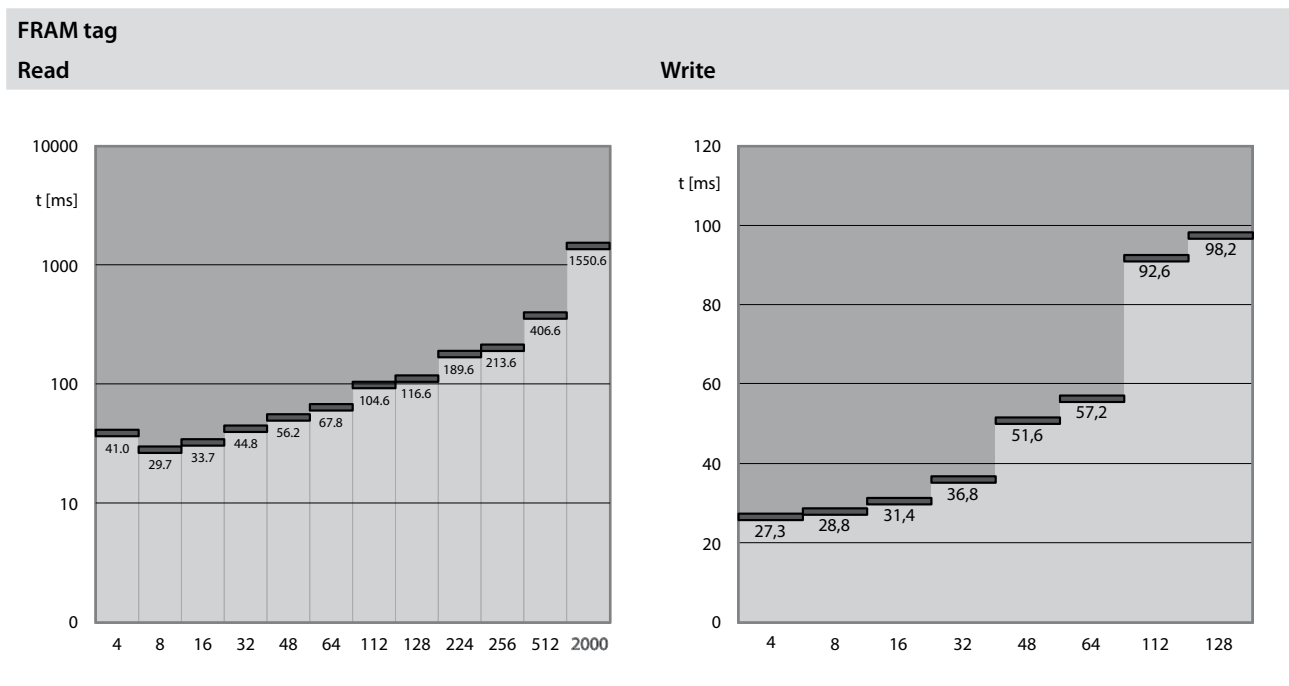

Fig. 31: Dwell times for reading and writing of FRAM tags

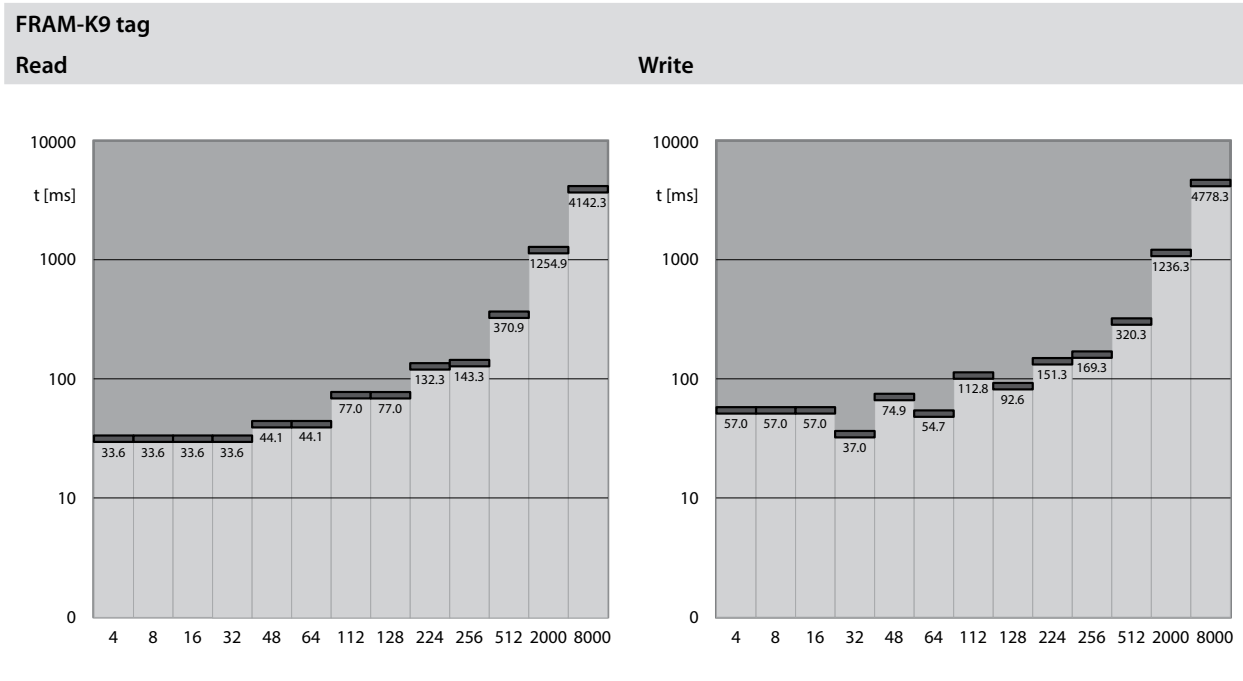

Fig. 32: Dwell times for reading and writing of FRAM-K9 tags

6.1.11 Passing Speed

The speed at which the tag can move past the read/write head depends on the combination of read/write head and tag and the data volume to be processed. Specific values for maximum speed and data volume can therefore only be given as examples.

The application parameters for Speed, Data capacity and Range can be changed for test purposes with the Turck BL ident® Simulator (available online at www.turck.com).

The processing time of the overall system must be taken into account as well as the data processing time in the read/write head. The time required for forwarding and processing the data in the overall installation can vary from application to application.

If your application is designed for a fast succession of tags, it may be necessary to reduce the speed at which the tags are moved past the read/write head.

6.1.12 Read/Write Distance

The achievable read/write distances depend on the relevant combination of tag and read/write head as well as the ambient conditions.

The possible read/write distance in the application depends on the following factors:

- Data volume to be read
- Passing speed

The HF read/write heads can achieve a range up to 1000 mm.



NOTE

A test of the application under actual conditions is therefore always required. The maximum read/write distance is only an idealized value under laboratory conditions.

The following properties may be different due to component tolerances, mounting location in the application, ambient conditions and the effect of materials (particularly metal and liquids):

- The achievable read/write distances may be reduced.
- The parameters for the achievable passing speed (read and write operations on the fly) and the maximum transmittable data volume also vary depending on the actual transmission in the relevant application.
- The recommended distance of tag to read/write head must be observed in order to ensure reliable read/write operations in the sensing range despite any deviations. The “recommended” and “maximum distance” entries are shown in the chapter “Combination of UHF read/write heads and tags”.

6.1.13 Dwell Time of the Tag

The dwell time T_d is the time in which the tag is in the transmission range of the read/write head on passing. During this time the read/write head and tag can exchange data with each other.

The dwell time T_d is calculated as follows:

- $T_d = L_{sr} / V_{TAG}$
- L_{sr} : Length of the continuously running transmission zone
- V_{TAG} : Speed of the tag in dynamic operation

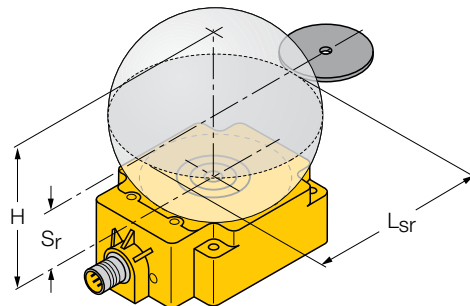

Fig. 33: Transmission zone in the HF range

In static operation, the dwell time must be at least as long as the communication between tag and read/write head.

In dynamic mode, the dwell time is determined by the system environment. The dwell time must be adapted to the transferred data volume.

The shorter the dwell time, the less the transferred data volume.

6.1.14 Calculating the Max. Quantity of User Data in Single Mode

The calculation of the maximum quantity of user data depends on the combination of tag and read/write head used.

Example:

A transport system moves pallets fitted with tags at a max. speed of $V_{TAG} = 1.0 \text{ m/s}$ in dynamic operation.

The following RFID components were selected:

- Read/write head: TB-M18-H1147
- Tag: TW-R30-K2

L = Length of the transmission zone (see operating data)

Calculate the dwell time of the tag:

$$t_v = L \times 0.8 / V_{TAG} = 0.018 \text{ m} / 1.0 \text{ m/s} = 0.018 \text{ s} = 18 \text{ ms}$$

Calculate max. user data (n_{max}) for read or write operations:

$$t_v / t_{Byte} = 18 \text{ ms} / 0.5 \text{ ms} = 36 \text{ bytes} \Rightarrow n_{max} = 36 \text{ bytes}$$

When the tag passes a maximum of 36 bytes can be read or written.



NOTE

The BL ident® Simulator at www.turck.com enables you to illustrate different operating states in dynamic operation.

6.1.15 Minimum Distance between Two Tags in Single Mode

The minimum distance between two tags in static mode depends on the size of the transmission zone.

The minimum distance between two tags in dynamic mode depends on the following factors:

- Size of the transmission zone
- Data volume
- Bus cycle time



NOTE

Appropriate tests to determine the minimum distance of successive tags must be carried out before startup.

6.1.16 Minimum Distance between Two Tags in Multiple Access

If the tags are located close together, it may not always be possible to ensure successful read/write operation.

Select as large a distance between tags as possible if you wish to access multiple tags located simultaneously in the transmission zone (bulk detection).

Information about the expected performance must be determined by carrying out a function test under the specific application conditions.

6.2 Clarifying the Requirements of UHF Applications

6.2.1 Transmission Frequency

The Turck BL ident® UHF system operates at nationally specified transmission frequencies between the tags and read/write heads. These national frequencies for UHF are required due to the frequency ranges individually specified by the national regulation bodies.

The operating frequency of the devices in the UHF band is for example 865...868 MHz for Europe and 902...928 MHz for the USA. The BL ident® read/write heads in the UHF band can therefore only be used in the countries they are intended for and must not be put into operation outside of these regions. As the BL ident® UHF tags are passive, and therefore do not radiate their own radio waves, these are suitable for use worldwide.

Turck offers different tag variants that are specially designed and optimized for national frequency bands in order to achieve as large a communication range as possible. Wide-band multi-range tags for international use are also available as an alternative.

The various Turck read/write heads support the following transmission frequencies:

- 865...868 MHz (e.g. for Europe)
- 866...868 MHz (e.g. for Russia)
- 902...928 MHz (e.g. for USA and Canada)
- 920...925 MHz (e.g. for China)
- 902...907.5 MHz and 915...928 MHz (e.g. Brazil)
- 917...920.8 MHz (e.g. for Korea)

The relevant national specifications for UHF such as frequency range, output and the status of any national regulations can be obtained from the Internet at:

<http://www.gs1.org/>

For more detailed information please contact the regulation authorities of the country where you wish to use the UHF RFID system.

HF RFID systems can be run parallel to UHF RFID systems in an installation.

6.2.2 Lifespan of the Tags

The passive tags do not require any batteries. Their lifespan is defined by the number of possible read/write operations.

- EEPROM tags ensure an unlimited number of read operations and 10⁴ or 10⁵ write operations.

6.2.3 Degree of Protection

Read/write heads with a high mechanical degree of protection (e.g. IP67/IP69K) are available for harsh industrial conditions or wash-down applications. Temperature-resistant tags up to 240°C are available for the high temperature range.

The interfaces for connecting a fieldbus system are offered in degrees of protection IP20 and IP67. The BL ident® product range also includes the appropriate connection cables in a suitable degree of protection.

6.2.4 Compatibility

Controller Systems

The BL ident® system is compatible with several different fieldbus controller systems. The modular design allows the system to be adapted to the selected fieldbus system. This enables it to be integrated easily in existing applications.

The BL ident® system supports the following fieldbus controller systems:

- PROFIBUS-DP
- DeviceNet™
- CANopen
- Modbus TCP
- EtherNet/IP™
- PROFINET
- EtherCAT®

BL ident® systems can be integrated into (existing) fieldbus systems. This makes it possible to network multiple BL ident® systems.

The guidelines for the maximum expansion of the fieldbus system used apply. Further information is provided in the startup manual (see also chapter “Other documents”).

Interoperability

A combination with systems of other suppliers is always possible thanks to international standards as well as standard technologies for the RFID sector.

The Turck RFID system is optimized for the combination of BL ident® read/write heads, tags and interface modules. Different performance characteristics must be expected when combined with the devices of other manufacturers.

6.2.5 Transmission Zone and Read/Write Distance

UHF technology makes use of the properties of an electromagnetic wave for data transmission. The recommended read/write distances depend on the combination of tag and read/write head, as well as the physical conditions of the surroundings. The distribution of the alternating electromagnetic field depends on the type of antennas in the tag and the read/write head, as well as the layout and characteristics of the physical environment (e.g. reflecting obstacles).

UHF Transmission Zone

A data exchange is only possible in the transmission zone. The size of the transmission zone depends on the combination of tag and read/write head. The shape and extent of the transmission zone are primarily determined by environmental factors, such as obstacles in the physical surroundings of the read/write head and the tag. Metallic objects or objects with a high permittivity in particular change the size and extent of the UHF transmission zone with reflected and transmitted radio waves. Obstacles that are not located directly in the connection line between tag and read/write head, but for example at the side or rear, also cause a change in the transmission zone.

The transmission zone can take on a more or less jagged shape – with fading inside it. The optimum reliability of the application can be ensured by planning sufficient reserve in transmission distances and access times.

Planning Reserve Transmission Distances

Starting from the maximum possible read distance D_{read_ideal} for a particular combination of read/write head and tag, only approx. 40 ... 80 % of the maximum possible distance D_{read_ideal} may actually be used for read operations, depending on the mounting conditions in actual applications. The possible distance for write operations may be even less, e.g. only 50 % of the maximum possible read distance D_{read_ideal} .

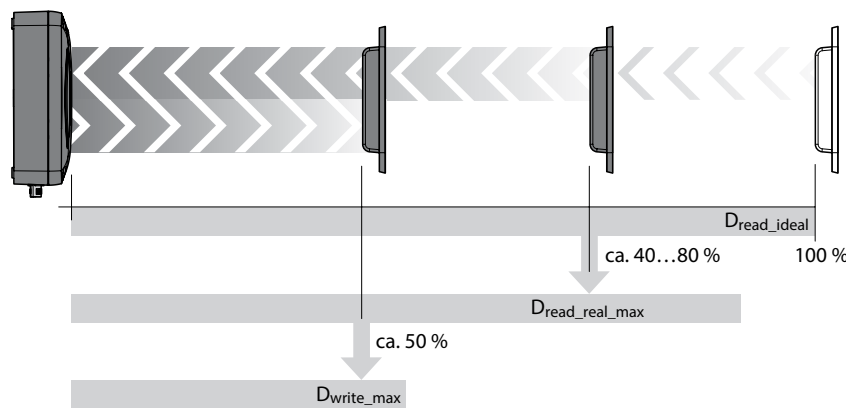

Fig. 34: Possible read/write distances



NOTE

Range tests in real conditions must be carried out in all cases.

6.2.6 Minimum Distance of Tag and Read/Write Head

With BL ident® a minimum distance between the tag and the read/write head is not necessary.

6.2.7 Permissible Motion Direction and Alignment of the Tags

The tags can move over the read/write head in any direction of movement if they are aligned parallel to the read/write head.

6.2.8 Reading and Writing in Static Mode with UHF

Individual Access

In static mode with UHF, the tag can be located at a read/write distance of several meters if it is placed in a fixed position precisely in front of the read/write head.

Multiple Access

UHF RFID systems in static mode enable the reading of a large number of tags. Due to the inhomogeneous UHF transmission zone, several attempts may be necessary to achieve a complete data transmission. Tags may not even be detected in this mode if they are located in a dead zone.

6.2.9 Reading and Writing in Dynamic Mode (on the Fly) with UHF

In dynamic mode the tag moves past the read/write head at a specific transverse speed according to the configuration. A data exchange is only possible in the transmission zone. The BL ident® UHF system in dynamic mode enables the reading of a large number of tags. Due to the inhomogeneous UHF transmission zone, several attempts may be necessary to achieve a complete data transmission. An additional time reserve for detecting all tags must therefore be included in planning.

6.2.10 Read Time/Write Time

The tag must be located in the sensing range of the read/write head for a specific time in order for all the required data to be read and written reliably. This read or write time depends on the following factors:

- Command type (write or read)
- Memory type of the tag (EEPROM or FRAM)
- Data volume
- Homogeneity of the electromagnetic field with UHF (interruption of the communication with moving tags due to field reflections and interference; interaction of radio waves with the environment)

The acquisition of data may be disturbed by the following factors:

- Electromagnetic interference
- Interference may cause the cancellation of the waves and fading.

6.2.11 Passing Speed

The speed at which the tag can move past the read/write head depends on the data volume to be processed, the combination of read/write head and tag, as well as the spatial conditions of the environment. Specific values for maximum speed and data volume can therefore only be given as examples.

The UHF system normally offers a higher read speed than the HF system. Many tags are detected simultaneously (bulk detection), fast moving tags are detected reliably.

The processing time of the overall configuration of the ID system must be taken into account as well as the data processing time in the read/write head. The time required for forwarding and processing the data in the overall installation can vary from application to application.

If your application is designed for a rapid succession of tags, it may be necessary to reduce the speed at which the tags are moved past the read/write head.

6.2.12 Read/Write Distance

The achievable read/write distances depend on the relevant combination of tag and read/write head as well as the ambient conditions.

The possible read/write distance in the application depends on the following factors:

- Transmission output of the read/write head: The higher the transmission output of the read/write head, the greater the read/write distance.
- Size and design of the tag: The larger the antenna of the tag, the greater the energy consumption and therefore the greater the read/write distance
- Absorption factor of materials in the spatial environment: The greater the absorption of the electromagnetic waves, the smaller the read/write read distance.
- Reflective properties of the environment: In an environment with a lot of reflective materials (e.g. in rooms with reflective surfaces, machines, concrete walls) the read/write distance can be considerably greater than in an environment with low reflective properties. Overreaches are just as possible as fading.
- Tag frequency tuning: Tags for which the frequency is optimized for a specific region (e.g. 865...868 MHz frequency band for Europe) offer in this region higher read/write distances than tags designed with a broad frequency band.

The UHF read/write heads typically have a sensing range of several meters.



NOTE

A test under actual conditions is therefore always required.

The maximum read/write distance is only an idealized value under laboratory conditions.

The following properties may be different due to component tolerances, mounting location in the application, ambient conditions and the effect of materials (particularly metal and liquids):

- The achievable read/write distances may be reduced.
- The parameters for the achievable passing speed (read and write operations on the fly) and the maximum transmittable data volume also vary depending on the actual transmission in the relevant application.
- The recommended distance of tag to read/write head must be observed in order to ensure reliable read/write operations in the sensing range despite any deviations. The "recommended" and "maximum distance" entries are shown in the chapter "Combination of UHF read/write heads and tags".

The write distance depends on the tag used and its mounting conditions. Depending on the application, the write distance is sometimes 30...50 % of the maximum read distance.



NOTE

Do not carry out write operations close to the limit of the transmission zone.

6.2.13 Dwell Time of the Tag

The dwell time T_d is the time in which the tag is in the transmission range of the read/write head on passing. During this time the read/write head and tag can exchange data with each other. In static operation, the dwell time must be at least as long as the communication between tag and read/write head. If communication is fault-free, the dwell time can be as long as required. If the tag is located in a dead zone due to interference, the dwell time is zero.

In dynamic mode, the dwell time is determined by the system environment. The dwell time must be adapted to the transferred data volume. The shorter the dwell time, the less the transferred data volume.

Communication in UHF RFID between the read/write head and the tag can fail on account of fading. Several transfer attempts may therefore be necessary to establish communication due to the inhomogeneous UHF field. When planning the dwell time, additional time must therefore be reserved for any repeat attempts.



NOTE

The number of automatic retries can be set via the offline parameters of the higher-level controller (PLC).

6.2.14 Minimum Distance between two Tags in Single Mode

The minimum distance between two tags in dynamic mode depends on the following factors:

- Data volume
- Bus cycle time



NOTE

Appropriate tests to determine the minimum distance of successive tags must be carried out before startup.

6.2.15 Requirements for Multiple Access

Multiple access means a read/write head can communicate with several tags at the same time. All tags must therefore be located in the transmission zone at the same time. In multiple access the tags are distinguished by the read/write head by means of their UII/EPC. The read/write head can thus address a tag selectively by means of its specific UII/EPC. The tags must have different UIIs/EPCs for multiple access. If the tags have the same UII/EPC, these must be individually written with different UIIs/EPCs for applications with multi-access. If the tags are located close together, it may not always be possible to ensure successful read/write operation. Select as large a distance between tags as possible if you wish to access multiple tags located simultaneously in the transmission zone (bulk detection). The minimum distance between the tags is 50 mm. Information about the expected performance must be determined by carrying out a function test under the specified application conditions.

6.2.16 Interaction with Several Read/Write Heads

In applications with several read/write heads run in parallel there is a risk that the tags are detected by different read/write heads at the same time. The detection of a tag by several read/write heads at the same time occurs particularly if the read/write heads transmit on the same channel (on the same frequency). The BL ident® system uses different processes in order to ensure that a tag is only detected by the appropriate read/write head. These processes vary according to the application region:

- Europe: Adaptive frequency agility according to ETSI 302 208 V1.2
- China, USA, Korea: Frequency hopping procedure according to FCC Rules Part 15

Adaptive Frequency Agility

With adaptive frequency agility the read/write head checks prior to transmission the four adjacent channels of the current transmit channel. The read/write head transmits if two adjacent channels above and two adjacent channels below the transmission channel are free. The read/write head transmits for a maximum of 4 s on one channel. If the adjacent channels are not free, the read/write head interrupts the transmission for 100 ms or jumps immediately to a free channel.

Frequency Hopping Procedure

With the frequency hopping procedure, the read/write head changes its transmit channel in a random or programmed sequence (FHSS – frequency hopping spread spectrum). The probability that two read/write heads are operating on the same frequency is reduced by the number of transmission channels:

Region	Number of transmission channels
USA, Canada, Brazil	50
China	16
Korea	6

Preventing Interaction when Using Several Read/Write Heads

Besides adaptive frequency agility and the frequency hopping procedure, the following are ways of preventing the interaction between read/write heads:
 Observe the minimum distances of the antennas between each other
 The minimum distance between two read/write heads using the same frequency depends on the maximum radiant power and the alignment of the antenna.

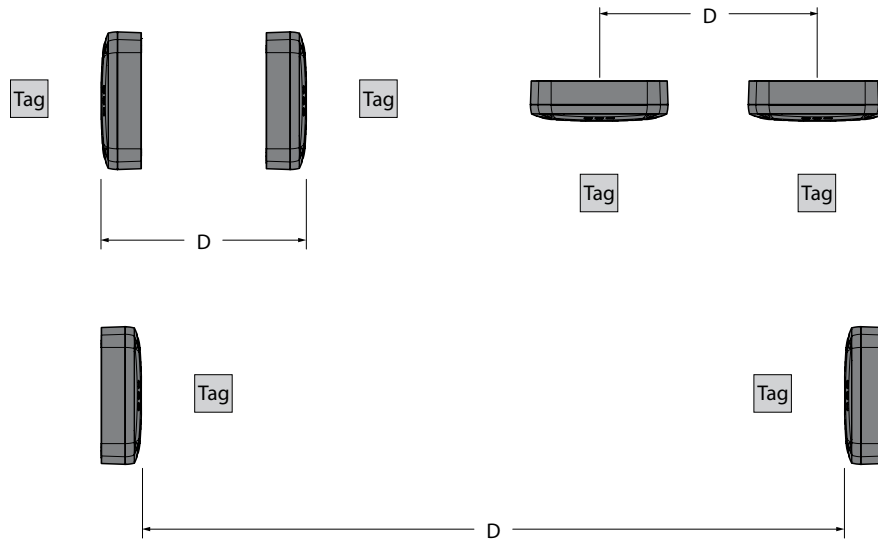

Fig. 35: Antenna alignment

Antenna alignment	Minimum distance D for TN...-Q175L200-H1147 with ERP = 1 W	Minimum distance D for TN...-Q120L130-H1147 with ERP = 0.5 W
Back to back	0.5 m	0.25 m
Side by side	1 m	0.5 m
Front to front	2.5 m	1.25 m



NOTE

The stated values do not take into account the effect of the tags.

Using Dense Reader Mode (DRM) (only for Use in Europe)

Dense Reader Mode (DRM) enables several read/write heads using the same transmission frequency and in close proximity to operate fault-free. The read/write head transmits on four transmission channels in compliance with ETSI EN 302 208 V1.2.1 and EPC Global. The response of the tag appears on the associated channels. Due to the large difference in signal levels between the transmit channels and the adjacent channels, Dense Reader mode offers significant benefits when a frequency is reused.



NOTE

When the read/write heads are used in Europe, the use of DRM filters is advantageous if several read/write heads are operated in a narrow space. The DRM filters can be switched on manually with the DTM for the read/write head.

Synchronizing Read/Write Heads through a Higher-Level Controller

Interference can be kept to a minimum if only one read/write head is always active for a minimum period. The read/write heads can be synchronized by the higher-level controller. The TDMA procedure should be used for the transmission.

Triggering Read/Write Heads

If read/write heads are triggered, the transmission field is only switched on if communication with the tag is required. If a tag is located in the detection range of the read/write head, the transmission field can be switched on, for example, by means of an additional sensor.

Creating a Channel Assignment Plan

Turck recommends the creation of a channel assignment plan for RFID applications which use adaptive frequency agility. If several read/write heads transmit on the same channel, they must be located as far apart as possible. The adaptive frequency agility is not available in all regions.

Region	Selective frequency selection (fixed frequency)	Adaptive Frequency Agility
Europe (ETSI)	allowed	allowed
Russia	allowed	allowed
USA/Canada	not allowed	not allowed
China	not allowed	not allowed
Korea	not allowed	not allowed
Brazil	not allowed	not allowed

Tuning Frequency Ranges and Channels

The following frequency ranges and channels are used for different regions.

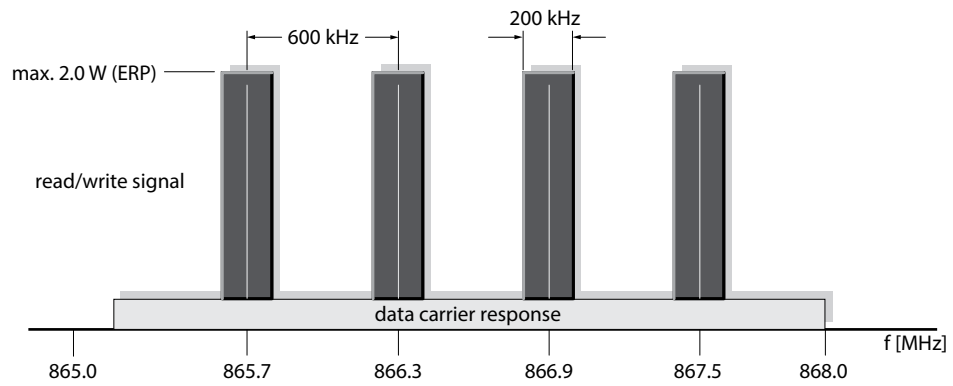

Fig. 36: Frequency ranges in Europe, adaptive frequency agility



NOTE

When using the read/write heads in Europe, use the four available channels equally.

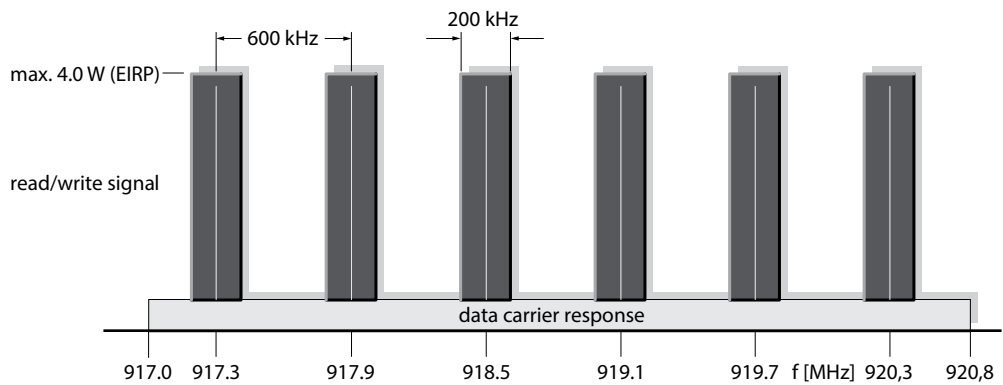

Fig. 37: Frequency ranges in Korea, Frequency hopping procedure

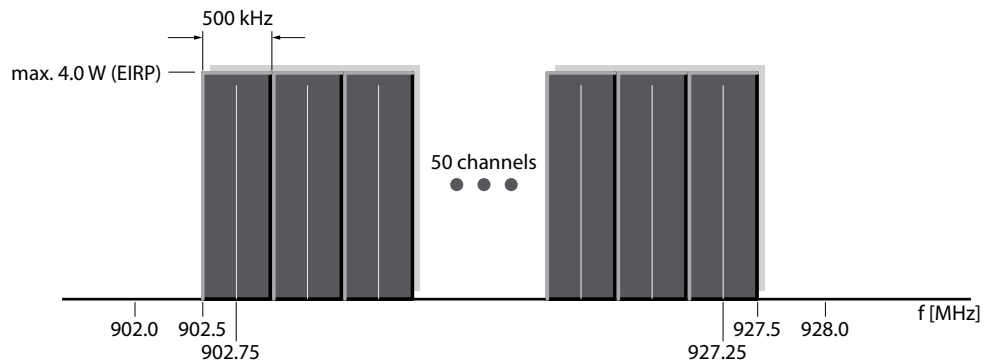

Fig. 38: Frequency ranges in the USA, Frequency hopping procedure

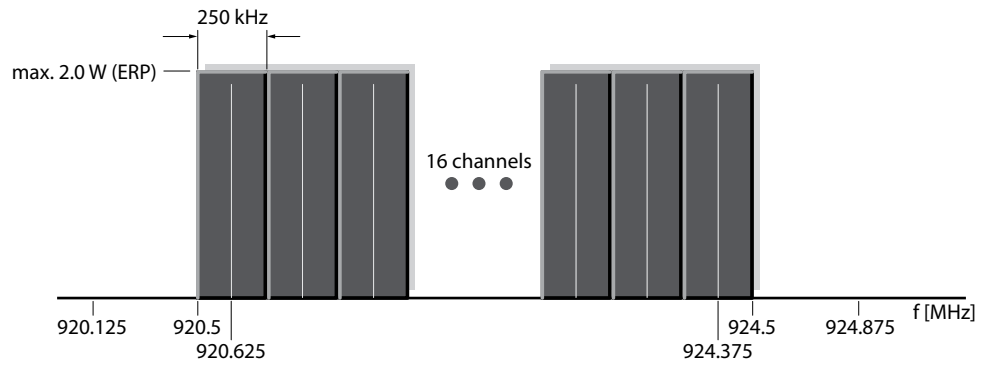

Fig. 39: Frequency ranges in China, Frequency hopping procedure

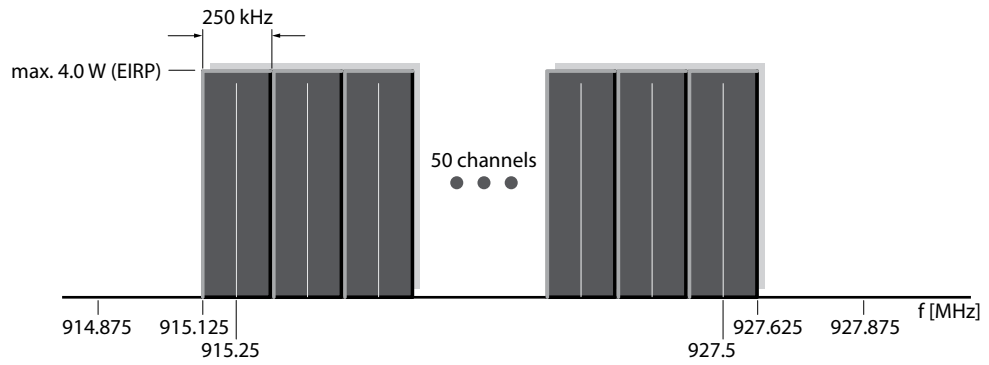

Fig. 40: Frequency ranges in Brazil, frequency hopping procedure

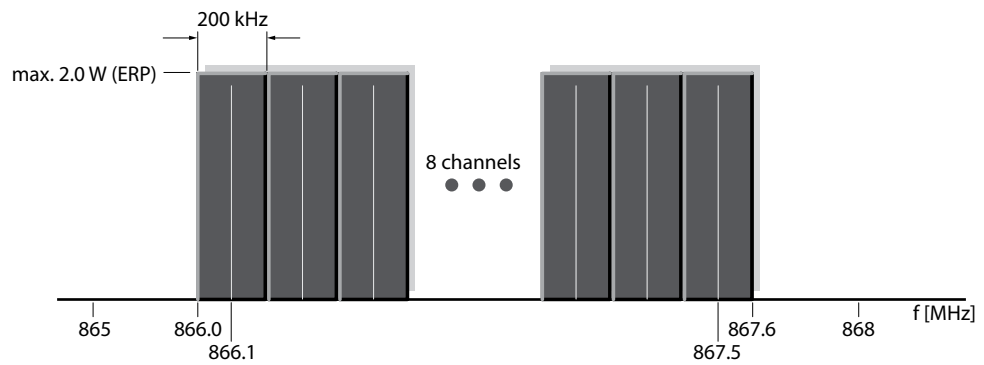

Fig. 41: Frequency ranges in Russia, adaptive frequency agility

Setting the Transmission Output and other Read/Write Head Parameters

In order to prevent mutual interference between components, read/write head parameters such as the transmission output can be set via the DTM.

Using Mechanical Shielding

Mechanical shielding (e.g. mesh grills) reduce interference, such as the faulty and unintended detection of tags positioned further away from the read/write head.

6.3 Effect on UHF RFID Systems

6.3.1 Electromagnetic Waves – Reflections and Interference

Electromagnetic waves in the UHF range behave and are propagated in a similar way to light waves. They are reflected on large objects such as ceilings, floors, walls, windows and interfere with each other. Interference may cause the following effects:

- Amplification of the waves and thus an increased read distance
- Cancellation of waves leading to fading

Real environments always contain several reflective objects which cause the interference of electromagnetic waves. It is therefore difficult to determine in advance the propagation paths and field strength of the electromagnetic waves for a particular location.



NOTE

Range tests in real conditions must be carried out in all cases.

6.3.2 Reducing the Effect of Reflections and Interference

Reducing Transmission Output

A reduced transmission output can keep interference to a minimum.

- Set the transmission output of the read/write head so that it is sufficient for a detection rate of 100 %.
- Synchronize read/write heads through a higher-level controller.
- Synchronize read/write heads using a higher-level controller in order to minimize interference.

6.3.3 Effect of Liquids and Non-Metallic Substances

Non-metallic substances and bodies as well as liquids can absorb UHF radiation. This can affect the field or cause the cancellation of the electromagnetic field depending on the size of a body and distance to the UHF radiation source.

Liquids and aqueous substances, ice, carbon have a higher RF attenuation in the UHF band. The electromagnetic radiation is partly reflected and absorbed.

Oil and petroleum based liquids cause a slight RFI attenuation in the UHF band. Electromagnetic waves penetrate these oil and petroleum based liquids and are only slightly attenuated.

6.3.4 Effect of Third Party Components

The performance of the UHF system greatly depends on the electromagnetic environment of the read/write heads. Although the requirements for electromagnetic compatibility are defined in the RED Directive, different components nevertheless produce mutual interference.

Reflections and Interference through Third-Party Components

Electromagnetic fields of the UHF read/write heads are weakened by absorbing materials and reflected by conductive materials. If electromagnetic fields are reflected, the reflecting fields and the fields of the read/write heads produce overlays (interference).

Third Party Components in the Same Frequency Band

UHF read/write heads can be severely affected by the transmission frequency of other components.

- Third party components in the same frequency band
- Third party components may transmit in frequency bands with adjacent bands which overlap the frequency band of the read/write head.

This may decrease the signal-to-interference ratio, thus reducing the performance of the RFID system.

6.4 Electromagnetic Compatibility (EMC)

6.4.1 Electromagnetic Compatibility – Definition

The electronic elements of an installation are exposed to different types of interference. This is due, for example, to the increasing density of installed components, the increasing amount of power electronics connected and the faster switching speeds involved. The higher the degree of automation, the greater the risk of mutual interference.

EMC is defined in the EU Directive 2014/30/EC as follows:

“Electromagnetic compatibility’ means the ability of equipment to function satisfactorily in its electromagnetic environment without introducing intolerable electromagnetic disturbances to other equipment in that environment.”

Interference sources arise through the combination of RFID with other parts of the overall system of an installation. When designing an installation it is therefore necessary to take precautionary measures to ensure EMC.

The RFI suppression of an installation as well as the observance of national specifications and regulations is the responsibility of the plant owner. The interference immunity of an installation mostly requires the implementation of several measures. Measures that are implemented when the system is installed can save later modifications and the need for fault rectification.

6.4.2 Cause of Electromagnetic Interference

Electromagnetic interference can only occur in an installation if the following elements are present:

- Interference source (emitter of interference, e.g. motor)
- Coupling (by which interference caused by the interference source reaches the interference sink, e.g. connection cable)
- Interference sink (recipient of interference, e.g. read/write head)

Interference cannot occur if one of these elements is missing, even if the interference source has strong interference emissions.

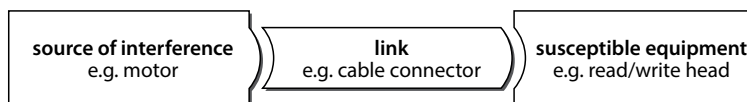

Fig. 42: Interference components

A system often has several interference sources and interference sinks. An interference sink can be an interference source at the same time and interact with other interference sources and sinks.

6.4.3 Basic Measures for Ensuring EMC

Measures to ensure EMC act at different locations (interference components) in order to reduce the effect on the interference sink as much as possible. The following describes a number of measures to ensure EMC.

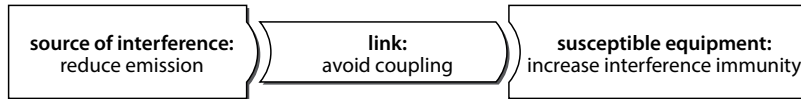

Fig. 43: Mutual interference of the interference components and EMC measures

It is particularly important to know the coupling paths involved in order to implement the appropriate counter measures.

Analyzing coupling Paths

Interference coupling is possible on the following four coupling paths:

- Galvanic coupling
- Capacitive coupling
- Inductive coupling
- Radiative coupling

The radiated interference on the coupling paths has different causes:

- Connection cables:
 - Incorrect or unfavorable wiring
 - Missing or incorrectly connected shield
 - Unfavorably located connection cables
- Control cabinet or housing:
 - Missing or incorrectly wired equipotential bonding
 - Missing or incorrect grounding
 - Unfavorably located arrangement
 - Insecurely mounted modules
 - Unfavorable control cabinet layout

In practice the coupling paths are often very complex and considerable experience is needed to analyze them. However, interference sources and interference sinks can be easily identified by measuring their emissions and appropriate countermeasures taken.

Shielding the Housing

- ▶ Install the device in a cabinet or a housing in order to protect it from external interference.
- ▶ Integrate the cabinet or housing in the chassis ground.
- ▶ Use partition plates to shield electromagnetic fields arising from inductances from the device.

Install a Ground Connection with a Large Contact Area

- ▶ Connect passive metal parts to the chassis ground using an HF low impedance connection across a large contact area.
- ▶ Connect passive metal parts and the central ground point with a large area connection.
- ▶ Incorporate the shield ground in the chassis grounding system (connect the shield ground to the chassis ground across a large contact area).

Planning the Cabling

- Divide the cabling into cable groups.
- Route cable groups separately.
- Always route power cables and data cables in separate ducts or bundles.
- Always introduce cables from one side and at only level into the cabinet.
- Route the data cables as close as possible to chassis surfaces.
- Twist the feed and return conductors of separately installed cables.
- Route the data cables between the read/write heads and the interface modules through the routing for the bus cable.

Shielding the Cables

- Shield the data transmission cables.
- Connect the shield of the data transmission cables at both ends.
- Shield the analog cables.
- Shield the analog cables at one end (e.g. on the drive unit).
- Connect the cable shields to the shielding bus over a large contact area at the cabinet entry.
- Fasten the cable shields with a low impedance contact using clamps.
- Feed the connected shield through to the module without interruption.
- Use braided shields.
- Do not use foil shields.

Line and Signal Filters

- Use line filters with metal housings.
- Connect the filter housing to the cabinet chassis using an HF low impedance connection across a large contact area.
- Do not fix the filter housing to painted surfaces.
- Fasten the filter at the control cabinet entry or in the direction of the interference source.

Install Devices in a Control Cabinet

Magnetic and electrical fields and electromagnetic waves can be kept away from the interference sink by using a metal housing. The easier the induced interference current can flow, the greater the intrinsic weakening of the interference field.

- Connect all housing sections with a low impedance connection.
- If the control cabinet panels are insulated from each other, an HF connection can be established using ribbon cables and HF terminals or HF paste.

Interference can be prevented through optimum control cabinet design. In this case the following applies as a general rule: The effect of the interference decreases as the distance between the interference source and interference sink increases.

- Install the interference source and the interference sink as far apart as possible.
- Install shielding plates to further decrease the interference.
- Signal cables should have a minimum clearance from power cables or load cables of 10 cm.
- Install correctly dimensioned line filters to avoid external interference via the network.
- Fit line filters directly at the cabinet entry.

Preventing Interference Sources

- ▶ Prevent the installation of interference sources that particularly occur with switched inductances.
Relays, contactors, fluorescent lights in the control cabinet and valves are particular sources of interference.
- ▶ Possible interference can be prevented through the use of RC circuits, free-wheeling diodes etc.
This also prevents stray inductive interference in the cables installed parallel to the coil cables.

Potential Equalization

Potential differences between different parts of a plant can arise due to the different design of the plant sections and different voltage levels. Equalizing currents then flow across the signal cables. Equipotential bonding prevents the occurrence of potential differences. Equipotential bonding should not be confused with the protective grounding. Protective grounding prevents the occurrence of excessive shock voltages in the event of equipment faults.

- ▶ Create a proper potential equalization:
- ▶ Use potential equalization cables with a 10 mm² cross section.
- ▶ Keep the distance between the signal cable and the associated equipotential bonding conductor as short as possible (antenna effect).
- ▶ Use a fine-stranded conductor (better high-frequency conductivity).
- ▶ When connecting to the central equipotential bonding strip (EBS), combine the power components and non-power components.
- ▶ Route the potential equalization cables of the individual modules directly to the central equipotential bonding strip.

Shielding Cables

Signal cables must be shielded in order to prevent the coupling of interference. The best shielding is achieved by installing the cables in steel tubes. However, the use of cables with braided shields is normally enough. An incorrectly connected shield has no shielding effect.

- ▶ Ensure correct shield connection.
- ▶ Provide the shield with a large-area connection since interference signals are frequently within a range > 10 kHz.
- ▶ Connect the shielding bus to the control cabinet housing using a low impedance connection across a large area.
- ▶ Fit the shielding bus as close as possible to the cable entry.
- ▶ Strip the cable and connect the cables clamped to the shielding bus with an HF clamp or using cable ties.
- ▶ Connect the shielding bus with the protective ground (PE).
- ▶ If intermediate connectors are used that do not have a suitable shield connection, route the shield by fixing cable clamps at the point of interruption.

6.4.4 Possible Disturbance Factors and Countermeasures in RFID Applications

Problem	Measures
The use of switched-mode power supply units may cause radiated interference via the current supply.	Use a stabilized power supply unit.
Interference via the serial connection cable.	Improve the cable shielding. Ground the read/write head.
Use of another RFID read/write head causes HF interference via the antenna.	Position the antennas further apart from each other. Otherwise, change the alignment of antennas to each other. Install suitable damping materials between the antennas. Reduce the power of the read/write heads.
Two radio frequency systems in the same frequency band. HF interference via the antenna.	Change the channel if the national radio regulations allow.

7 Maintenance

- ▶ Always keep the firmware of the system components up to date. Contact Turck for firmware updates.

8 Repair

The system must not be repaired by the user. Decommission the device if it is faulty. Observe our return acceptance conditions when returning the device to Turck.

8.1 Returning Devices

If a device has to be returned, bear in mind that only devices with a decontamination declaration will be accepted. This is available for download at <http://www.turck.de/en/retoure-service-6079.php> and must be completely filled in, and affixed securely and weather-proof to the outside of the packaging.

9 Disposal



The devices must be disposed of correctly and must not be included in normal household garbage.

10 EC Conformity/Approvals

10.1 Interfaces

Type	Ident no.	CE	UL	ATEX	IECEX	FM	TR-CU
BL20-GW-DPV1	6827234	x	x	Zone 2	x	x	Ex
BL20-E-GW-DP	6827250	x	x	Zone 2	x	x	Ex
BL20-GWBR-DNET	6827168	x	x	Zone 2	x	x	Ex
BL20-E-GW-DN	6827301	x	x	Zone 2	x	x	Ex
BL20-E-GW-CO	6827252	x	x	Zone 2	x	x	Ex
BL20-GW-EN	6827237	x	x	Zone 2	x	x	Ex
BL20-PG-EN	6827249	x	x	Zone 2	x	x	Ex
BL20-GW-EN-IP	6827247	x	x	Zone 2	x	x	Ex
BL20-PG-EN-IP	6827248	x	x	Zone 2	x	x	Ex
BL20-E-GW-PN	6827377	x	x	-	-	-	x
BL20-E-GW-EC	6827380	x	x	-	-	-	x
BL67-GW-DN	6827183	x	x	-	-	-	x
BL67-GW-DPV1	6827232	x	x	-	-	-	x
BL67-GW-EN	6827214	x	x	-	-	-	x
BL67-GW-EN-PN	6827228	x	x	-	-	-	x
BL67-GW-PN-AC	6827345	x					
BL67-PG-DP	6827240	x	x	-	-	-	x
BL67-PG-EN	6827241	x	x	-	-	-	x
BLCDN-2M12S-2RFID-S	6811002	x	x	-	-	-	-
BLCDN-6M12LT-2RFID-S-8XSG-PD	6811049	x	x	-	-	-	-
BLCDN-4M12L-2RFID-S-2RFID-S	6811055	x	x	-	-	-	-
BLCDP-2M12MT-2RFID-A	6811166	x	x	-	-	-	-
BLCDP-6M12LT-2RFID-A-8DI-PD	6811173	x	x	-	-	-	-
BLCDP-6M12LT-2RFID-A-8XSG-PD	6811174	x	x	-	-	-	-
BLCDP-2M12MT-2RFID-S	6811177	x	x	-	-	-	-
BLCDP-6M12LT-2RFID-S-8DI-PD	6811178	x	x	-	-	-	-
BLCDP-6M12LT-2RFID-S-8XSG-PD	6811179	x	x	-	-	-	-
BLCCO-2M12S-2RFID-S	6811300	x	x	-	-	-	-
BLCCO-6M12LT-2RFID-S-8XSG-P	6811303	x	x	-	-	-	-
BLCEN-2M12MT-2RFID-S	6811450	x	x	-	-	-	-
BLCEN-2M12MT-2RFID-A	6811484	x	x	-	-	-	-
BL67-2RFID-A	6827225	x	x	-	-	-	Ex
BL67-2RFID-S	6827305	x	x	-	-	-	Ex
BL20-2RFID-A	6827233	x	x	Zone 2	x	x	Ex
BL20-2RFID-S	6827306	x	x	Zone 2	x	x	Ex
BL67-B-2M12	6827186	x	x	-	-	-	Ex
BL20-S4T-SBBS	6827046	-					

10.2 HF Read/Write Heads

Type	Ident no.	CE	UL	CCC	ATEX	FCC	IC	FDA
TB-M18-H1147	7030001	x	x	x	-	x	x	-
TN-M18-H1147	7030002	x	x	x	-	x	x	-
TB-M30-H1147	7030003	x	x	x	-	x	x	-
TN-M30-H1147	7030004	x	x	x	-	x	x	-
TN-CK40-H1147	7030006	x	x	x	-	x	x	-
TN-Q80-H1147	7030007	x	x	x	-	x	x	-
TN-S32XL-H1147	7030008	x	x	x	-	-	-	-
TNLR-Q80L400-H1147	7030204	x	-	x	-	x	x	-
TB-EM30WD-H1147	7030221	x	x	x	-	x	x	x
TN-EM30WD-H1147	7030222	x	x	x	-	x	x	x
TN-EM18WD-H1147	7030223	x	x	x	-	x	x	x
TB-EM18WD-H1147	7030224	x	x	x	-	x	x	x
TNLR-Q80-H1147	7030230	x	x	x	-	x	x	-
TNLR-Q80L400-H1147L	7030234	x	-	x	-	x	x	-
TN-Q14-0.15-RS4.47T	7030235	x	x	-	-	x	x	-
HT-IDENT-H1147	7030236	x	-	-	-	-	-	-
TNLR-Q80-H1147-EX	7030303	x	-	x	x	x	x	-
TB-EM18WD-H1147-EX	7030381	x	-	x	x	-	-	-
TN-EM18WD-H1147-EX	7030382	x	-	x	x	-	-	-
TB-EM30WD-H1147-EX	7030385	x	-	x	x	-	-	-
TN-EM30WD-H1147-EX	7030386	x	-	x	x	-	-	-
TNSLR-Q80WD-H1147	7030418	x	x	x	-	x	x	-
TNSLR-Q42TWD-H1147	7030424	x	x	x	-	x	x	-
TNSLR-Q350-H1147	7030454	x	x	x	-	x	x	-
TB-Q08-0.15-RS4.47T	7030553	x	-	-	-	x	x	-
TN-M18-H1147/C53	7030728	x	x	-	-	x	-	-
TB-M18-H1147/C53	7030729	x	x	-	-	x	-	-
TN-M30-H1147/C53	7030730	x	x	-	-	x	-	-
TB-M30-H1147/C53	7030731	x	x	-	-	x	-	-
TN-CK40-H1147/C53	7030732	x	x	-	-	x	-	-
TNSLR-Q42TWD-H1147/C53	7030733	x	x	-	-	x	-	-
TB-Q08-0.15-RS4.47T/C53	7030778	x	-	-	-	x	-	-
TN-Q14-0.15-RS4.47T/C53	7030779	x	x	x	-	x	-	-

10.3 UHF Read/Write Heads

Type	Ident no.	CE	UL	FCC	IC	RTA	KCC	ANATEL	MPTRF
TN865-Q175L200-H1147	7030452	x	-	-	-	-	-	-	-
TN865-Q120L130-H1147	7030520	x	-	-	-	-	-	-	-
TN840/920-Q120L130-H1147	7030536	-	-	-	-	x	-	-	-
TN840/920-Q175L200-H1147	7030466	-	-	-	-	x	-	-	-
TN902-Q120L130-H1147	7030535	-	x	x	x	-	-	-	-
TN902-Q175L200-H1147	7030457	-	x	x	x	-	-	-	-
TN917-Q120L130-H1147	7030537	-	-	-	-	-	x	-	-
TN917-Q175L200-H1147	7030513	-	-	-	-	-	x	-	-
TN866-Q120L130-H1147	7030671	-	-	-	-	-	-	-	x
TN866-Q175L200-H1147	7030669	-	-	-	-	-	-	-	x
TN902/915-Q120L130-H1147	7030670	-	-	-	-	-	-	x	-
TN902/915-Q175L200-H1147	7030668	-	-	-	-	-	-	x	-

11 Glossary

AIDA

AIDA (Automation Initiative of German Automobile Manufacturers) is the name of the association of leading automobile manufacturers, which aims to establish a uniform standard for production processes in the sector.

Air interface

The air interface is the RFID transmission zone resulting from the combination of tag and read/write head. The air interface makes it possible to exchange information and supply the tags with power (only with passive tags).

Antenna, active

An antenna normally consists of a coil which is used as a transmitting and receiving unit. The radio signals are transmitted between the read/write head and the tag via the antenna. An active antenna is integrated in the electronics of the read/write head.

Anti-collision procedures

Anti-collision procedures are processes for the detection of multiple tags in the air interface of a read/write head. To avoid a possible collision when receiving data, the tags are not addressed exactly at the same time but in very rapid succession or via different frequencies within the frequency band.

BL compact

BL compact is the name of a compact I/O system from Turck with IP67 protection. BL stands for Bus Link.

BL ident®

BL ident® stands for "Bus Link Identification" and is the name of the modular RFID system from Turck.

BL20

BL 20 is the name of a compact I/O system from Turck with IP20 protection. BL stands for Bus Link.

BL67

BL 67 is the name of a modular I/O system from Turck with IP67 protection. BL stands here for Bus Link.

Bulk detection

Bulk detection denotes the simultaneous detection (write/read) of multiple tags with a read/write head. The read operations are carried out directly in succession. Each tag must only be detected once. Possible processes for this are, for example, the anti-collision procedure.

Bus

A bus is a group of signal conductors for the transfer of data and control information between different components (e.g. CPU, memory, I/O level) according to a defined protocol. A bus can be composed of a number of parallel cables for data transfer, addressing, control and power supply.

Class 1 DP master

A class 1 DP master (DPM1) is a central controller of a PROFIBUS-DP system, which exchanges information with the remote slaves cyclically in a fixed telegram cycle. The DPV1 functions (acyclical transmission of user data) can be used as an additional option. Typical devices are PLCs or PCs.

Class 2 DP master

Class 2 DP masters (DPM2) are used exclusively to transmit acyclical user data in a PROFIBUS-DP system and are used for tasks such as commissioning, maintenance and diagnostics in order to configure connected components. Typical devices include engineering or operating devices. A class 2 DP master does not have to be permanently connected to the bus system.

Configuring (modular fieldbus stations)

The configuration of a fieldbus station describes the systematic arrangement of the electronic modules according to their functions within a station.

Closed-loop system

In a closed-loop RFID system, the tags fitted to a workpiece carrier, container or a pallet do not leave the internal production process or intralogistic area of the company.

CODESYS

CODESYS (Controller Development System) is a development environment and programming system in accordance with IEC 61131-3 for PLCs and programmable automation components.

CPU

A CPU (central processing unit) is the processor of a computer which is the central element for handling all important computing processes.

Data retention

Data retention denotes the lifespan of the data on a tag in years, depending on the ambient temperature and other environmental factors.

Data carrier

see tag

Degree of protection

The degree of protection to IEC/EN 60529 and DIN 40050-9 defines the protection of device housings from contact and the penetration of foreign objects and water. The most typical degrees of protection for Turck devices are

- IP20: protection from solid foreign bodies with $\varnothing > 50$ mm; no protection from water (only use in the switch cabinet)
- IP65: full protection from dust and protection from water jets
- IP67: full protection from dust and protection from water with intermittent immersion
- IP69K: full protection from dust and protection from water with high pressure/steam cleaning

DPV1

DPV1 is an enhanced functionality of PROFIBUS-DP which allows the acyclical transfer of user data with acyclical communication functions in addition to the cyclical process data. The acyclical services are conducted at the same time and in addition to the cyclical process data transmission with lower priority.

DTM

DTM stands for Device Type Manager and denotes the application independent driver for computer-programmed devices and communication devices within an FDT defined frame application (such as PACTware™). The DTM includes:

- User interface for the device
- Device logic and parameterization

EAN

The EAN (European Article Number) is the previous designation (discontinued since 2009) for the internationally standardized global trade item number, GTIN.

EEPROM

An EEPROM (electrically erasable programmable read only memory) is a non-volatile electronic memory module, which is provided to ensure that data stored on it can only be read and not electronically deleted and reprogrammed.

EIRP – effective isotropic radiated power

EIRP denotes the radiated power including antenna gain. The EIRP value of antenna gain is based on an isotropic radiator.

Electronic module

The electronic modules provide the different functions of the Turck modular I/O systems in a fieldbus station, and are independent of the particular fieldbus used. The electronic modules are fitted to the base modules and form with them a functional unit. The electronic module remains independent of the wiring and can thus be replaced at any time with an electronic module of the same product series with the same functions. Possible functions:

- Digital inputs and outputs
- Analog inputs and outputs
- Technology modules such as RFID
- Power supply

EMC

By electromagnetic compatibility (EMC) is meant the ability of an electrical device to operate satisfactorily in an electromagnetic environment without adversely affecting or being adversely affected by other electrical equipment.

EPC

The electronic product code (EPC) is an internationally used key and coding system for the unique identification of products, packaging and product types through the individual allocation of serial numbers.

ERP – effective radiated power

ERP denotes the radiated power including antenna gain. The ERP value of antenna gain is based on a half-wave dipole.

FDT

FDT stands for Field Device Tool and describes the interface definition between the specific device DTMs used and the frame application (such as PACTware™). The FDT includes:

- Standard user environment for all DTMs
- User management
- Management of the used DTMs
- Network configuration

Fieldbus

A fieldbus connects the stations in the field (such as sensors and actuators) in order to communicate with the process components (such as PLC, SCADA, industrial PC). A fieldbus typically offers a high transmission security and a real-time behavior. Fieldbus systems can be exposed to severe external conditions and are primarily used in industry.

FRAM

An FRAM or Ferro RAM (ferroelectric random access memory) is a non-volatile electronic memory module based on crystals with ferroelectric properties, which can be read or written. The key features of the FRAM memories are the low power consumption, short write times and a high degree of data reliability.

Function block

A function block is a self-contained program which provides different status, input and output bits as well as routines. Several designated instances of a function block can be created.

Gateway

By gateway is meant the hardware and software which connects different networks with different protocols (protocol converters). For this all the information of a telegram apart from the user data is converted from the source protocol to the destination protocol. In the modular Turck I/O systems, the gateway is the head of the particular fieldbus station and forms the interface between the fieldbus and the field level.

Gateway, programmable

The gateways which can be programmed with CODESYS according to IEC 61131-3 can be used as a PLC to independently control applications or act as a subordinate instance in the network for faster remote signal processing. Programmable gateways are thus used to relieve the load of the central controller of a network.

GSD

The GSD file (general station description, previously "device master file") describes the properties of the devices which are used in PROFIBUS-DP. The GSD file is a text file and is supplied in different languages. Configuration tools require the device information in order to complete the configuration and commissioning. The GSD file normally contains general information (e.g. vendor name and version) and with modular devices the communication features (e.g. module designations, texts for diagnostic messages, parameter options, parameter names).

HF

HF stands for high frequency technology and denotes the RFID applications using the frequency band around 13.56 MHz. The HF frequency band is defined by the international ISO 15693 standard.

IEC 61131

IEC standard (International Electrotechnical Commission) 61131 is an internationally recognized standard for programmable controllers, which specifies aspects such as the functional features, requirements and programming language of a PLC.

Initialization (memory media)

When a memory is initialized, the memory space is reserved and filled with initial values (such as variables, code, buffer, ...) required for the execution of tasks.

Inlay tags

An inlay is an RFID microchip and an antenna which are attached to a foil. These RFID inlays are further processed into a smart label for use as an RFID tag. Inlays are normally used as RFID tags before the conversion or the respraying process.

Interface set (BL ident®)

The interface sets of the BL ident® system are fieldbus stations with a permanently defined scope. They have a modular design and are each provided with a gateway and one of up to four RFID modules or as a compact module of the BL compact or TBEN system. The interface sets are available with up to 16 channels and for the simultaneous use of up to eight read/write heads. The gateway or compact station used depends on the fieldbus in use and the performance range of the RFID modules.

I/O system

An I/O system is the collection and distribution point for digital information or analog signals on the field level. With point-to-point wiring, the signals of the field instrumentation are collected on a remote I/O station in the plant, transferred to a digital protocol and fed via a bus cable to the controller.

ISO 15693

The ISO 15693 standard is a worldwide ISO standard which specifies the physical properties of the RFID tag (e.g. dimensions, load, UV and X-radiation, maximum temperature), the air interface (e.g. carrier frequency, modularization, transmission output, data rates, coding), the initialization as well as the anti-collision protocol and the transmission protocol.

ISO 18000-6C

The ISO 18000 6C standard is compatible with EPC Global Class 1 Generation 2 (also called UHF Gen 2) and defines the physical and logical requirements for a transmission process between a passive tag and a read/write head in the UHF frequency band.

Item level tagging

The identification of all goods at item level with tags is known as item level tagging.

LSB

LSB stands for "Least significant bit"; in a digital signal of a specific length, the bit that represents the lowest value.

MSB

MSB stands for "Most significant bit"; in a digital signal of a specific length, the bit that represents the highest value.

Open-loop system

In an open-loop RFID system the tags are fitted on each product (item level tagging) and leave the company after the internal production or intralogistics process.

Operating frequency

The operating frequency describes the frequency band which is used to exchange information between the tag and the read/write head. The frequency bands of the RFID applications are precisely specified for every technology and there are additional national restrictions on the operating frequency used.

PACTware™

PACTware™ stands for "Process Automation Configuration Tool" and is an open and manufacturer-independent operator interface for the plant-wide operation of devices, systems and communication components. The connection between the PACTware™ operator interface and the specific device DTM is implemented via an FDT interface. PACTware™ enables the devices of an installation to be configured and operated simply, quickly and efficiently, as well as diagnosed if required.

PIB (Proxy Ident Block)

The Proxy Ident Function Block (PIB) is based on a specification of the PNO (PROFIBUS user organization). In this profile manufacturers and suppliers have set communication conventions between an industrial controller and an identification system. The result is a standardized interface which guarantees interoperability between systems of different manufacturers. The uniform communication mechanism between field device and function block in the controller guarantees end-to-end data consistency. The PIB also provides a number of status bits and commands. Besides the interoperability, the benefits are the fast implementation of the system in the central controller, rapid project implementation and investment protection. The BLident® modular RFID system from Turck is based on an open standard. A PIB function block for the Siemens S7 controller series is provided as well as a function block based on CODESYS, which can be operated, for example, in the programmable gateways of BL20/BL67 modular I/O systems.

Polarization (RFID)

Polarization describes the alignment of an electromagnetic wave. This is either linear or circular polarization. Linearly polarized waves can be aligned vertically or horizontally depending on the alignment of the antenna. This may be a problem for RFID systems in which tags are fastened to goods as labels, as it mostly cannot be determined precisely how the antenna of the tag is aligned to the field. The solution is the radiation of circularly polarized electromagnetic waves. For this two antennas are arranged vertically to each other and one antenna is triggered with a 90° out of phase signal. Polarization is either left-hand or right-hand circular polarization (LHCP and RHCP).

(Protective) ground

In electrical engineering, the name given to a conductive area with an electrical potential of zero at any point. The electrical potential of the ground may not equal zero in the area around grounding devices, in which case this is called the "reference ground".

Reading device

See read/write head

Read rate

The read rate is the maximum speed at which a tag is read. The read rate is defined in bits or bytes per second.

Read distance

The read distance is the maximum distance at which a read/write head can read data from a tag. With HF technology the read distance is virtually identical to the write distance; With UHF technology the read distance is normally greater than the write distance.

Read/write head

A read/write head transmits via radio signal data from a controller to a tag and reads the data stored on the tag and forwards this to a controller. The core element of the Turck read/write heads is an active antenna.

RFID

RFID stands for radio frequency identification, and describes the contactless or non-visual identification of objects using electromagnetic waves. For this data can be read as well as stored.

RFID/UHF read/write distance

The achievable read/write distances depend on the relevant combination of tag and read/write head. The possible read/write distance depends on the data volume to be written and read as well as the speed at which the tag moves past the read/write head. The UHF read/write heads normally have a read/write distance of several meters.

Note: The maximum read/write distance of several meters is only an idealized value under laboratory conditions. The achievable distances may be reduced due to component tolerances, mounting location in the application, ambient conditions and the influence of materials (particularly metal and liquids). The parameters for achievable passing speed (read and write operations on the fly) and the maximum transmittable data volume also vary depending on the actual transmission in the relevant application. Depending on the tag, the maximum write distance can be considerably less (e.g. 50%) than the maximum read distance.

A test under actual conditions is therefore always required. All UHF read/write heads of the BL ident® system are suitable for single and multiple access to tags.

Smart label tags

Smart label tags are particularly inexpensive flat tags made of foil. The smart label tags are available in different variants, which can be stuck or printed etc., and are frequently used as disposable tags.

Tag

A tag is a mobile data memory consisting of a memory chip and an antenna which can be written or read in an RFID system without contact. The tag receives the incoming signals and responds to the signals "independently".

Tag, active

Active tags have their own internal energy source; the energy is used for the active transmission of information and to supply the internal memory.

Tag, passive

Passive tags have no independent power supply and take their power for transmitting information and for writing in the internal memory from the alternating electromagnetic field, which is generated by the read/write head. This type of tag is mainly used in the Turck BL ident® system.

Tagging

Tagging denotes the fitting of an object with a tag.

TBEN

TBEN denotes Turck's compact RFID and I/O modules with an Ethernet interfaces with degree of protection IP67/IP68/IP69K.

Tracking and tracing

Tracking and tracing denotes the tracking and tracing of movable objects in intralogistics or logistics. The process provides information on where goods are located at a specific time.

Tracking denotes the location of a specific object at a defined time.

Tracing indicates events involving the materials, semi-finished goods and end products on their journey through the production and logistics chain.

Transponder

See tag

Transmission frequencies of Turck BL ident®/UHF

The Turck BL ident® system operates at nationally specified transmission frequencies in the UHF range of (865...928 MHz) between the tags and read/write heads. UHF systems in this frequency band achieve a higher read/write distance than HF systems, typically several meters. The national frequencies for UHF are required due to the frequency ranges individually specified by the national regulation bodies. The BL ident® read/write heads in the UHF band can therefore only be used in the countries they are intended for and must not be put into operation outside of these regions.

As the BL ident® UHF tags are passive, and therefore do not radiate their own radio waves, these are suitable for use worldwide. Turck offers different tag variants that are specially designed and optimized for national frequency bands in order to achieve as large a communication range as possible. Wide-band multi-range tags for international use are also available as an alternative.

The various Turck read/write heads support the following transmission frequencies:

- 865...868 MHz (e.g. for Europe)
- 902...928 MHz (e.g. for USA and Canada)
- 920...925 MHz (e.g. for China)
- 902...907.5 MHz and 915...928 MHz (e.g. Brazil)
- 917...920.8 MHz (e.g. for Korea)

The relevant national specifications for UHF such as frequency range, output and the status of any national regulations can be obtained from the Internet at:

- <http://www.gs1.org>

For more detailed information please contact the relevant authorities of the country where you wish to use the UHF RFID system.

Transmission zone (RFID)

see Air interface

UHF

UHF stands for ultra high frequency technology and denotes the RFID applications using the frequency bands between in the range 865...928 MHz. The requirements for the frequency and are defined in ISO 18000-6C, the specification of the frequency bands is made nationally by the relevant national authorities and is retained by the EPC.

The frequency ranges covered by Turck products are:

- 865...868 MHz: Europe
- 866...868 MHz: Russia
- 902...928 MHz: North and South America, except Brazil
- 902...907.5 MHz and 915...928 MHz: Brazil
- 920...925 MHz: China
- 917...920.8 MHz: South Korea

Wink command

A Wink command enables the identification of stations on an Ethernet network. If a gateway is an Ethernet station and receives a Wink command, it responds with an optical signal (e.g. flashing LED).

Write distance

The write distance denotes the maximum distance that a read/write head can bridge to store data on a tag. With HF technology the write distance is virtually identical to the read distance; With UHF technology the write distance is normally less than the read distance.

TURCK

Over 30 subsidiaries and
60 representations worldwide!

10000267 | 2017/04



www.turck.com